

DETAIL A
SCALE 1 : 2
NEMA 5-15P

ELECTRICAL PARAMETERS:

- SINGLE PHASE, 12A/100-120V, 1.4kVA
- INPUT TYPE: NEMA 5-15P, 10' CORD
- OUTPUT TYPE: (10) NEMA 5-20R, 12A

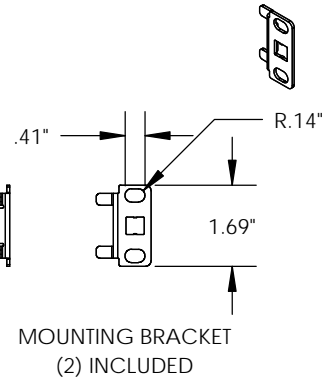
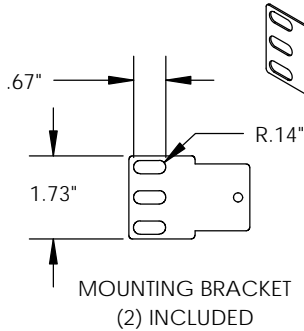
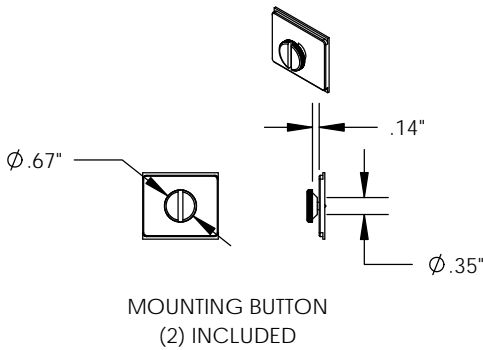
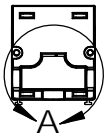

NOTES:

1. INSTALLATION SHALL COMPLY WITH ALL APPLICABLE NATIONAL, STATE, AND LOCAL CODES.
2. PLEASE REFER TO PRODUCT DOCUMENTATION FOR FURTHER INFORMATION.
3. MOUNTING BUTTONS ARE AN ALTERNATIVE MOUNTING METHOD TO THE TOOLLESS MOUNT FOR 3RD PARTY ENCLOSURES. BUTTONS ARE PROVIDED WITH THE UNIT. DETAILED INSTALLATION INSTRUCTIONS CAN BE FOUND IN THE PROVIDED MANUAL.
4. MOUNTING HARDWARE NOT INCLUDED.

<p>*** NOTICE *** THIS DOCUMENT CONTAINS CONFIDENTIAL AND/OR PROPRIETARY INFORMATION INTENDED FOR USE ONLY BY THE INDIVIDUAL(S) PROVIDED. NEITHER THIS DOCUMENT, NOR ANY INFORMATION CONTAINED HEREIN, MAY BE COPIED, DISTRIBUTED, DISCLOSED TO ANY THIRD PARTY OR USED IN ANY MANNER OTHER THAN FOR WHICH IT HAS BEEN PROVIDED, WITHOUT THE PRIOR WRITTEN CONSENT OF LEGRAND. MANUFACTURING RELEASE, PRODUCT SPECIFICATIONS AND STANDARDS ARE SUBJECT TO CHANGE WITHOUT NOTICE.</p>					WWW.LEGRAND.US	
			<p>TITLE RACK PDU, BASIC, 1U, 12A, 120V, (10) 5-20R, 5-15P CORD</p>			
	NAME	DATE	SIZE	CAD FILE	DWG NO	REV
DWN	CAC	1/7/2019	A	LP21110C	LP21110	00
CHK	MM	1/7/2019	SCALE		SHEET	
APPR	CV	1/7/2019			1 OF 1	