

2

1

NOTES:

- 1. MATERIAL: NYLON
- 2. UL LISTED
- 3. COLORS AVAILABLE: IVORY, BROWN, BLACK, ALMOND, LIGHT ALMOND, WHITE
- 4. INSTALLATION HARDWARE INCLUDED

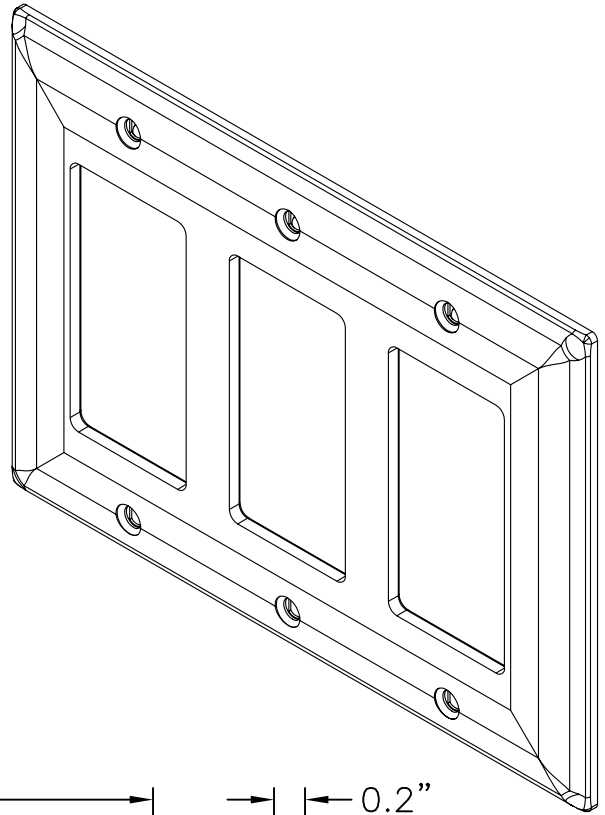

B

B

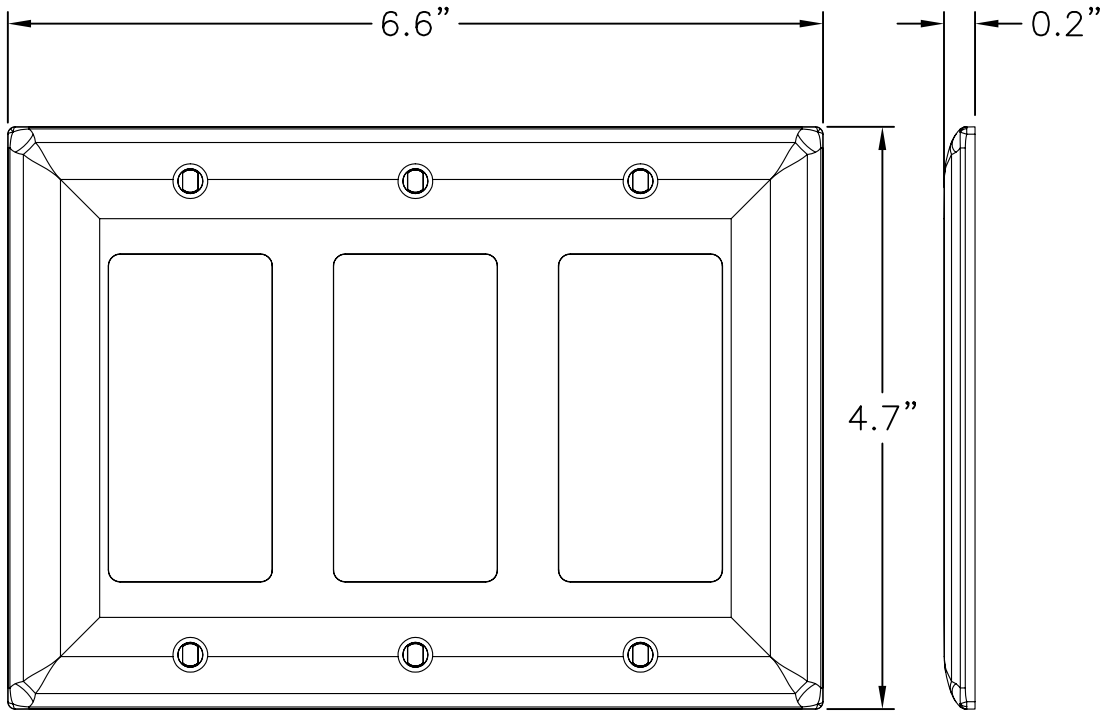

A

A

PROPRIETARY AND CONFIDENTIAL
 THE INFORMATION CONTAINED
 IN THIS DRAWING IS THE SOLE
 PROPERTY OF On-Q/LEGRAND.
 ANY REPRODUCTION IN PART OR
 AS A WHOLE WITHOUT THE WRITTEN
 PERMISSION OF On-Q/LEGRAND
 IS PROHIBITED. DRAWING IS SUBJECT
 TO CHANGE WITHOUT NOTICE.

on·Q

legrand

P.O. Box 60907
 Middletown, PA 17106-0907
 1-800-321-2343

TITLE:

3 GANG DECORATOR WALL PLATE

SIZE A	DWG NO WP1208	FILE NAME CD-WP1208	CUST REV 1
REVISED DATE 11/09/07	SCALE NONE	SHEET 1 OF 1	

2

1