

ADVANCED OPERATION



Groups

Use a Wireless Miro universal dimmer in conjunction with one or more Miro DRD8 Wireless Multilocation Controllers to control one lighting circuit from multiple locations. Binding the DRD4 and DRD8 devices together in the same Group enables them to work in exactly the same way, from any of the control locations.



You can include other Miro wireless devices in the Group. Just remember that all devices in the Group operate when one member operates. If you increase the brightness on one circuit in the Group, all circuits will increase brightness.

Set the House ID (see Set House ID) before setting up Groups.

Creating a New Group

1. Go to any device that you want to include in the Group. Press . The device LED flashes yellow, and all other devices in the house flash green. You now have 5 minutes to complete this process.
2. To include or exclude a device in the Group press  on the device until the LED changes color. **Yellow** flashing LED = Included in the Group
Green flashing LED = NOT included in the Group
If you get to a device and it is NOT flashing, the 5 minute binding process timer may have expired. Go back to step 1 and repeat.
3. Return to the device used in step 1 and press  to terminate Group binding. All LEDs revert to solid green. Now, all the devices in the Group control their load circuit in exactly the same manner.

Adding a Dimmer to a Group in an Existing System

1. Go to a device that is in the Group where you want to add the dimmer. Press . The device LED and all members of the Group flash yellow. The new dimmer flashes green.
2. Press  on the new dimmer until its LED flashes yellow.
3. Return to the device used in step 1 and press . All LEDs are solid green.

Scene Control

The Miro Wireless Universal Dimmer may be easily incorporated into room and whole house preset scenes. The Miro Installation Guide provides more information about configuring scenes and presets.

Instructions for installation and use are included with the relevant Miro wireless room and whole house control devices. Application support information and the Miro Installation Guide are available online.

CLEANING

Clean using a cloth dampened only with water and a little mild detergent.

Use of solvents or hydrocarbon-based cleaners may cause permanent damage.

TROUBLESHOOTING



During Set House ID, the LED is not flashing on some wireless Miro devices.

- **If LED is solid green before initiating House ID binding:**
The device already has another House ID. Reset it to the factory default so that it can be bound to the desired House ID. Resetting to factory defaults is described in the "I need to start over" issue.
- **If LED is solid yellow after initiating House ID binding:**
The device may be out of range of the initiating device. Add a MRR2G Miro Wireless Repeater to boost signal range.

I made a configuration mistake. I need to start over.

You can reset any Miro wireless device to factory default settings by pressing and holding  until the LED changes to solid yellow (approximately 10 seconds). During the process, the LED flashes yellow and when complete, it changes to solid yellow. The device can then be reconfigured, exactly like any new device (see the Set House ID section).

The Dimmer does not work and the status LED is flashing red

- **at 1Hz (5 times in 5 seconds):**
The dimmer has detected an unsuitable load or a load below 25 watts. To clear the fault condition, tap  and wait for the LED to turn green. Disconnect power, check the load, restore power and try again.
- **at 2Hz (10 times in 5 seconds):**
The dimmer has detected an overload condition and has shut down. To clear the fault condition, tap  and wait for the LED to turn green. Disconnect loads in excess of rated load and try again.
- **at 3Hz (15 times in 5 seconds):**
The dimmer has detected a short-circuit condition and has shut down. To clear the fault condition, tap  and wait for the LED to turn green. Remove power, rectify the short-circuit condition, restore power, and try again.

FCC NOTICE

This equipment has been tested and found to comply with the limits for a Class B digital device, pursuant to part 15 of the FCC Rules. These limits are designed to provide reasonable protection against harmful interference in a residential installation. This equipment generates, uses and can radiate radio frequency energy and, if not installed and used in accordance with the instructions, may cause harmful interference to radio communications. However, there is no guarantee that interference will not occur in a particular installation. If this equipment does cause harmful interference to radio or television reception, which can be determined by turning the equipment off and on, the user is encouraged to try to correct the interference by one or more of the following measures:

- Reorient or relocate the receiving antenna.
- Increase the separation between the equipment and receiver.
- Connect the equipment into an outlet on a circuit different from that to which the receiver is connected.
- Consult the dealer or an experienced radio/TV technician for help.

Caution: Any changes or modifications to this device not explicitly approved by manufacturer could void your authority to operate this equipment.

Warranty Information

Manufacturer warrants its products to be free of defects in materials and workmanship for a period of five (5) years. There are no obligations or liabilities on the part of manufacturer for consequential damages arising out of, or in connection with, the use or performance of this product or other indirect damages with respect to loss of property, revenue or profit, or cost of removal, installation or reinstallation.

Legrand Customers contact:



301 Fulling Mill Road Suite G
Middletown, PA 17057
Phone: 800.321.2343
www.legrand.us/onq

Please
Recycle



IS-0516

Vantage Customers contact:



1061 South 800 East
Orem, UT 84097
Phone: 800.555.9891
www.vantagecontrols.com

DRD4

Wireless Universal Dimmer



Installation Instructions

Specifications

Voltages	120VAC, 60Hz
Maximum Load Rating	600W
Minimum Load Required	25W
Load Type Compatibility	.25-600W

Incandescent and quartz halogen lamps

The following are limited to a maximum load of 500W:

Magnetic low voltage transformers, dimming rated electronic low voltage transformers, dimming rated cold cathode neon ballasts, dimming rated 2-wire fluorescent (Advance MK X or equivalent) and compact fluorescent ballasts

U.S. Patent 6,175,220. Other utility, design, and foreign patents pending.

 **legrand**[®]

 V A N T A G E

UNIT DESCRIPTION

The Miro Decorator DRD4 Wireless Universal Dimmer provides dimming of various lighting load types.

Load Types

Use the Miro Decorator Wireless Universal Dimmer for these load types (at 120V):

- Incandescent & quartz halogen lamps (25-600W)
- Dimmable, 2-wire fluorescent and compact fluorescent fixtures, magnetic or electronic low voltage, neon or cold cathode fixtures or diode equipped lamps (25-500W)



CAUTION

To reduce the risk of overheating and possible damage to other equipment, do not install to control a receptacle, or a motor-operated appliance.



CAUTION

Afin de réduire le risque de surchauffe et la possibilité d'endommager d'autres matériels, ne pas installer pour commander une prise, ou un appareil à moteur.

Do not mix different load types on the same dimmer.

Do not use with fluorescent fixtures other than those listed.

Derating

When more than one dimmer is installed in a multi-gang box, it is necessary to reduce the maximum load on each dimmer:

- For a dimmer in either end position of a multi-gang box, reduce its maximum load by 100W.
- For a dimmer in a central position of a multi-gang box, reduce its maximum load by 200W.

Miro Wireless

Miro wireless devices use radio signals to communicate with each other to control lighting and other types of electric loads in selected areas. Miro wireless devices use the 900MHz band for high-speed control communication. Using the patented "frequency-agile" Top Dog™ technology, Miro wireless devices avoid interference with other 900MHz devices, such as cordless phones and baby monitors.



CAUTION



**TURN THE POWER OFF AT THE CIRCUIT BREAKER
BEFORE INSTALLING THE DIMMER.**

INSTALLATION

For ease of installation, manufacturer recommends use of a deep wall box.

1. Disconnect power to circuit by turning circuit breaker OFF before installation.
2. Remove existing wall plate and switch.
3. Strip existing wires 1/2" (12.7mm).
4. Wire the LINE (black), NEUTRAL (white), LOAD and GND (green or bare) supply wires to the correspondingly marked screw terminals, according to the wiring diagram below.
5. Attach the wall plate.
6. Switch the circuit breaker back ON.

INSTALL IN COMPLIANCE WITH ALL APPLICABLE CODES & STANDARDS.

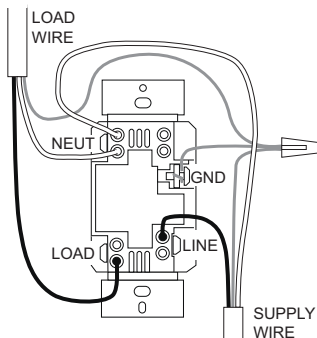

Failure to follow these instructions may cause
personal injury or equipment damage.





SET HOUSE ID

All Miro wireless devices installed in the same home must acquire the same unique House ID before use. This process is known as house binding. Each Miro wireless device is bound to all other Miro wireless devices in the house.

New Installation

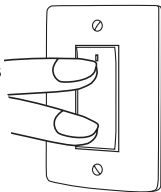

1. With all devices installed and energized, make sure that every Miro wireless device LED is yellow. If any LED is off, be sure the circuit breaker is on and the device is correctly installed.
2. Press  on any device paddle until the LED flashes yellow (about 2 seconds). This indicates that it has acquired a unique House ID.
3. Make sure that all other Miro wireless device LEDs are flashing green, indicating that they have acquired the same House ID.
4. Return to the device used in step 2, which is still flashing yellow. Press  until the LED changes to solid green (about 2 seconds). All device LEDs in the house change to solid green, indicating house binding is complete.



When you see  in the instructions, firmly press and hold both the top and bottom of the device paddle until the LED changes (about 2 seconds).



Adding a Device to an Existing Installation

If you're adding or replacing a device in a Miro wireless installation that is already operating, the new device must acquire the same House ID as the other Miro wireless devices in the house. After the new device is powered up, the LED should be solid yellow. This indicates that it has not yet acquired a House ID. To acquire the House ID for the existing system:

1. Press  on any previously bound device until the LED flashes yellow (about 2 seconds).
2. Verify that the newly added device LED is flashing green, indicating that it has acquired the House ID.
3. Return to the same previously bound device used in step 1 and press  until the LED changes to solid green (about 2 seconds). All device LEDs should now be solid green.

Fluorescent Setup

If the dimmer will operate 2-wire fluorescent or compact fluorescent loads, a special configuration step is required; if not, skip ahead to "Operation."

1. Press and hold  until the LED flashes yellow (about 2 seconds).
2. Press the top of the device paddle  until LED briefly flashes red.

3. Press and hold ⇅ until the LED changes to green (about 2 seconds).
4. To reconfigure the dimmer to control non-fluorescent loads, repeat the above steps 1-3, but press the bottom of the device paddle ↓ rather than ↑ in step 2; the LED briefly flashes green to confirm the cancellation of fluorescent operation.

OPERATION

↑	Tap once	Fade the circuit to its last-used level
↑↑	Tap twice	Full bright
—↑—	Press and hold	Increase the present level
↓	Tap once	Fade the circuit to OFF
—↓—	Press and hold	Decrease the present level

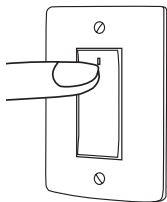

When you see ↑ in the instructions, touch the top of the switch as directed.

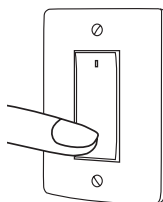

When you see ↓ in the instructions, touch the bottom of the switch as directed.

The dimmer may feel warm to the touch during normal operation.

Replacing Lamps

When a lamp must be replaced, use the Air Gap Isolation feature for safety. To activate the feature:

Press ↓ FIRMLY, so that the paddle clicks and latches in. Make sure the status LED is extinguished, indicating that it's safe to relamp.

To release and return to normal operation, press ↑.

Power Fail Memory

After a power failure, all Miro devices automatically return to the state they were in immediately prior to loss of power. All configuration and scene control information is preserved.

REV	DESCRIPTION	INT:	REV. DATE	APPROVED
1	ECO# C01694	MCL	8/15/06	CG
2	ECO# C02414	DR		

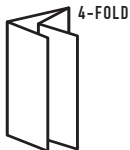

TITLE BOX PAGE ONLY.
DO NOT MAKE FILM • DO NOT PRINT

- Print: 2-sides
- Ink Color: Black
- Paper: White 16lb (60g/m sq)
Uncoated, prefer recycled stock
- Final trim size: 16" (Wide) x 6" (High).
- Four (4) fold.
- Final folded size: 4" (Wide) x 6" (High).



IF YOU HAVE ANY QUESTIONS REGARDING SPECIFICATIONS OR REQUIRE ADDITIONAL FILE FORMATTING, PLEASE CONTACT Mary Jo Sowinski.
 Phone: 408-486-7511
 Email: maryjo.sowinski@wattstopper.com

All information in this drawing is the property of Watt Stopper/Legrand and cannot be copied or used without the written approval of Watt Stopper/Legrand.

Drawn by	SOWINSKI	 Watt Stopper  legrand® SANTA CLARA, CALIFORNIA		
PLM				
MarCom		Title: DRD4 Installation Instructions		
Engineering				
QA				
TITLE BOX PG	Scale: 1:1	Drawing #:	Orig. Drawing Date: 10 AUG 06	Rev. #:
			Revision Date: 26 SEP 07	