

TYPICAL FIBER RACEWAY SHOWN (SOLD SEPARATELY)

TYPICAL SUSPENSION MTG KIT

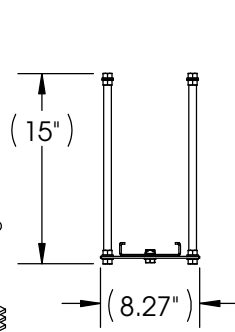

4" DUCTS SUSPENSION KIT
12mm THD ROD

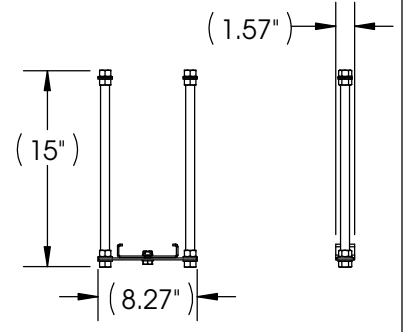

4" DUCTS SUSPENSION KIT
16mm THD ROD

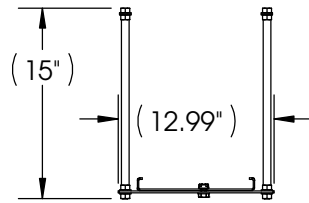

8" DUCTS SUSPENSION KIT
12mm THD ROD

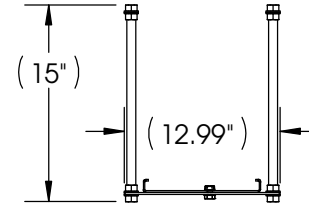

8" DUCTS SUSPENSION KIT
16mm THD ROD

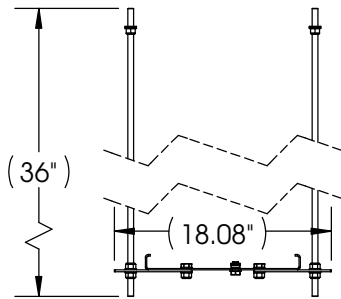

12" DUCTS SUSPENSION KIT
12mm THD ROD

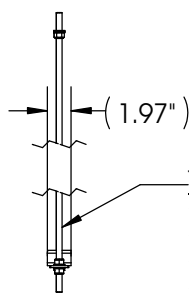

THESE KITS CONTAIN:
(1) DUCT MTG BRKT
(2) STRAIGHT BRKTS
(2) THREADED RODS
(SEE DESCRIPTION)
(2) ROD SLEEVES
(12) FLT WASHERS
(2) DUCT MTG BOLT
(2) BRKT MTG SCREWS

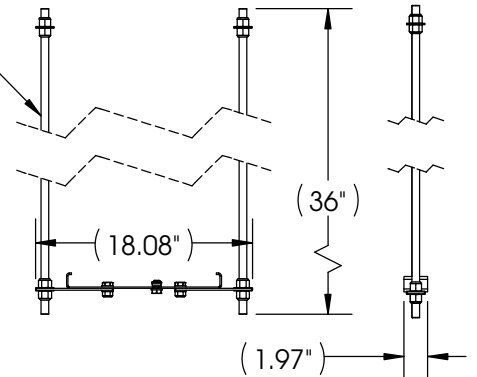

12" DUCTS SUSPENSION KIT
5/8 THD ROD

NOTES:

- TWO PLACE DECIMAL DIMENSIONS ARE APPROX. DUE TO METRIC TO INCH CONVERSION.
- IT IS RECOMMENDED TO SUPPORT THE RACEWAY EVERY 36" (900mm).
- MOUNTING BRACKETS SHOULD BE MOUNTED CLOSE TO A JOINER IF POSSIBLE.
- KIT CONTENTS ARE CLEAR ZINC & BLACK BRACKETS.

SIZE IN/(MM)	ORTRONICS P/N	KIT CONTENTS:
12mm THREADED ROD FOR 4" (100mm) DUCTING	MMFSUSK124	EACH KIT CONTAINS: (EXCEPT AS SHOWN) (1) DUCT MTG BRKT (SEE SIZE) (1) STRAIGHT MTG BRKT (2) THREADED RODS (SEE SIZE) (2) THREADED ROD SLEEVES (8) MOUNTING NUTS (1) DUCT MOUNTING BOLT (9) FLATWASHERS
16mm THREADED ROD FOR 4" (100mm) DUCTING	MMFSUSK164	
12mm THREADED ROD FOR 8" (220mm) DUCTING	MMFSUSK128	
16mm THREADED ROD FOR 8" (220mm) DUCTING	MMFSUSK168	
12mm THREADED ROD FOR 12" (300mm) DUCTING	MMFSUSK1212	
5/8" THREADED ROD FOR 12" (300mm) DUCTING	MMFSUSK5812	

*** NOTICE ***
THIS DOCUMENT CONTAINS CONFIDENTIAL AND/OR PROPRIETARY INFORMATION INTENDED FOR USE ONLY BY THE INDIVIDUAL(S) PROVIDED. NEITHER THIS DOCUMENT, NOR ANY INFORMATION CONTAINED HEREIN, MAY BE COPIED, DISTRIBUTED, DISCLOSED TO ANY THIRD PARTY OR USED IN ANY MANNER OTHER THAN FOR WHICH IT HAS BEEN PROVIDED, WITHOUT THE PRIOR WRITTEN CONSENT OF ORTRONICS, INC. MANUFACTURING RELEASE, PRODUCT SPECIFICATIONS AND STANDARDS ARE SUBJECT TO CHANGE WITHOUT NOTICE.



125 EUGENE O'NEILL DRIVE
NEW LONDON, CT 06320
TEL: 860-445-3800
FAX: 860-405-2990
WWW.ORTRONICS.COM

TITLE		MM FIBER RACEWAY, SUSPENSION KIT W/ THREADED ROD			
NAME	DATE	SIZE	CAD FILE	DWG NO	REV
DWN	J.QUINN	A	MMFSUSKXXYYC	OR-MMFSUSKXXYY	01
CHK	J.LUCY	SCALE	WEIGHT	SHEET	
APPR	C.VACCA	1:8		1 OF 1	