

# TITAN™ INCANDESCENT DIMMER MAGNETIC LOW VOLTAGE DIMMER INSTALLATION INSTRUCTIONS

Pass & Seymour

legrand

P/N 340837 Rev. B

**INCANDESCENT DIMMERS:** These dimmers are for use with Incandescent and Halogen lamps.

**CAUTION:** To reduce the risk of overheating and possible damage to other equipment, do not install to control a receptacle, a fluorescent light, a motor-operated appliance, or a transformer supplied appliance.

- Do not use this dimmer with incandescent lamps whose power requirements exceeds maximum power (stated in Watts) of this control.
- Do not connect this dimmer to power source other than 120VAC, 60 Hz only.
- Use copper wire only.
- A 50W minimum load is required.

**MAGNETIC LOW VOLTAGE DIMMERS:** These dimmers are for use with Magnetic Low Voltage Incandescent and Halogen lamps.

**CAUTION:** To reduce the risk of overheating and possible damage to other equipment, do not install to control a receptacle, a fluorescent light, or a motor-operated appliance. Connect only in a 120VAC, 60Hz circuit to control the primary winding of a transformer supplied incandescent and halogen lamp. The maximum VA rating of this dimmer applies to the transformer input, not the load on the transformer secondary.

- Do not use to control a solid state electronic low voltage transformer.
- Do not use with inoperative or missing lamps. Use of this dimmer with inoperative or missing lamps can create an over current condition which may damage the transformer. Use transformers that incorporate thermal protection or a fuse at the primary windings.
- Use copper wire only.
- A 50VA minimum load is required.

## PACKAGE CONTENTS

One of the following Dimmers:

### Narrow Dimmers

### Wide Dimmers

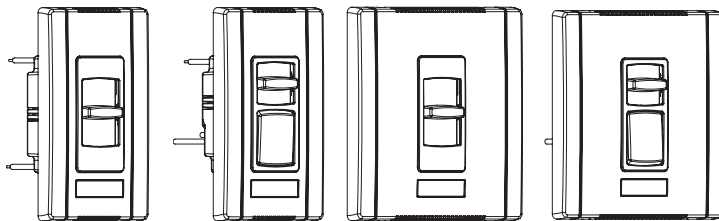

Cat no.:

CD700

CD1100

CDLV700

CDLV1100

Cat no.:

CD703P

CD1103P

CDLV703P

CDLV1103P

Cat no.:

CD1600

CD2000

CDLV1600

Cat no.:

CD1603P

CD2003P

CDLV1603P

### Wire Nuts

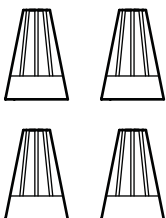

### Coupler



### Small Coupler



**IMPORTANT NOTES** Read the following before installation:

**WARNING:** To prevent severe shock or electrocution, always turn power OFF at the service panel before installing this dimmer, working on the circuit, or changing a lamp.

- To be installed by a certified electrician or other qualified person.
- Requirements for wire strip length and wire connections.

## WIRE NUT USAGE CHART

Wire Combinations	Strip Lengths	Color
1#14 & 1#16; 1#14 & 2#18; 2,3#16; 1#16 & 1-3#18; 3-5#18; 2#18	1/2" Except 9/16" For #16 & #18 AWG	Orange
1#10 & 1#14; 1#12 & 1#14 2, 3#14; 2#14 & 1,2#16; 2#14 & 2,3#18; 1#14 & 1-4#16; 1#14 & 1-4#18	1/2" Except 5/8" For #16 AWG	Yellow
1#10 & 1,2#12; 1#10 & 1-3#14; 2,3#12; 1#12 & 1-3#14; 1#12 & 3#16; 3,4#14	7/16" Except 1/2" For #16	Red
1#14 & 1,2#16; 1#14 & 1,2#16; 2,3#16; 2-5#18	7/16" For #14 & #16 1/2" For #18	Ivory

**Use Only Copper Wire With This Device.**

- Use a separate neutral wire for each phase of a multiphase system containing a dimmer, and for high power single phase applications where flickering is present.
- All dimmers can be damaged by improper wiring. Check for short circuits prior to installing the dimmer.

Procedure for short circuit check:

- Disconnect power to the circuit by removing fuse or turning circuit breakers OFF.
  - Install a switch instead of the dimmer. Turn the switch to the "on" position.
  - Turn power ON. If the circuit breaker trips, a short is present. If the light fails to turn ON and OFF with the switch, the wiring may be incorrect.
  - Correct wiring, if necessary and retest.
  - Install the dimmer only after the light operates properly with the switch.
- Protect from dirt and dust. The dimmer can be damaged from contaminants encountered during the construction process. If lighting is required prior to the construction process completion, then a switch should be temporarily installed in place of the dimmer. The dimmer should not be installed until the construction process is complete.
  - **Any dimmer damaged by improper installation is not covered under warranty.**
  - It is normal for the dimmer to feel warm during operation.
  - Cleaning Instructions: Wipe dimmer with a damp, clean cloth. DO NOT clean the dimmer with chemicals or cleaning solutions.

## WALL PLATE LABELING SYSTEM

These dimmer wall plates contain a label holding slot. A 0.33" x 1.5" label can be placed in this label holding slot. These labels can be printed from an Avery® standard template: Divider tab inserts 8-Tabs or equivalent.

Install the label with the following procedure:

1. Disconnect power to the circuit by removing fuse or turning circuit breakers OFF.
2. Remove the wall plate.
3. Slide the label in from the back side of the wall plate (as shown at right).

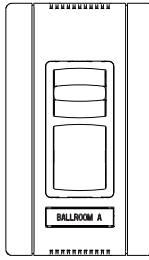
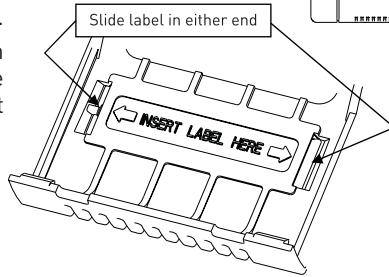

## WIRING DIAGRAMS

Table 1

Dimmer Catalog #	Diagram #
CD700, CD1100, CDLV700, CDLV1100 CD1600, CDLV1600, CD2000	1
For Single Pole Installation of: CD703P, CD1103P, CDLV703P, CDLV1103P CD1603P, CDLV1603P, CD2003P	2
For 3-Way Installation of: CD703P, CD1103P, CDLV703P, CDLV1103P CD1603P, CDLV1603P, CD2003P	3
For 4-Way Installation of: CD703P, CD1103P, CDLV703P, CDLV1103P CD1603P, CDLV1603P, CD2003P	4

DIAGRAM 1 (Single-Pole Wiring)

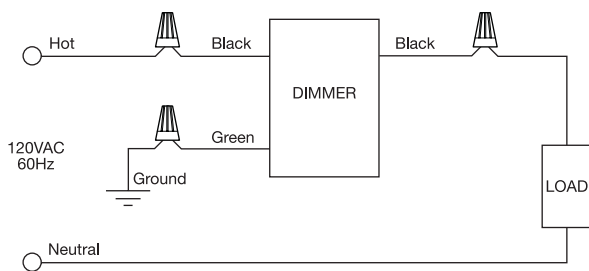

DIAGRAM 2 (Single-Pole Wiring Using 3-Way Preset Dimmer)

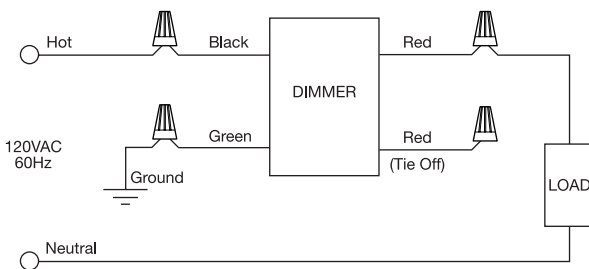
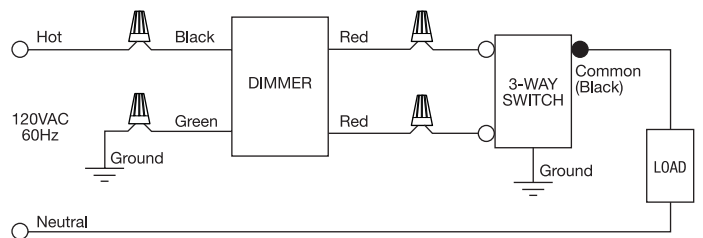
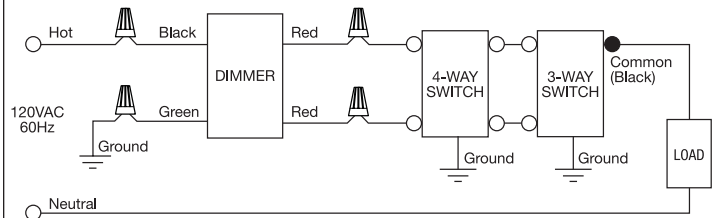

DIAGRAM 3 (3-Way Wiring)



NOTE: Dimmer may be wired on either side (line or load) of the switch.

DIAGRAM 4 (4-Way Wiring)



NOTE: Dimmer may be wired on either side (line or load) of the switch.

## SINGLE GANG INSTALLATION INSTRUCTIONS

1. Disconnect power to circuit by removing fuse or turn circuit breakers OFF before installing.
2. **For existing installations:** Remove wall plate and switch mounting screws, pull existing switch from wall box. **For new installations:** Install a 1-gang wall-box.
3. Disconnect existing switch from circuit. **3-way installation:** Identify the "COMMON" wire (wire connected to the terminal marked common or odd colored terminal). For "new" installation identify wire connected to power source or to the load.
4. Connect dimmer as shown in the wire diagram with appropriate sized wire connectors (see Table 1).
5. Install dimmer in wall box, with the word "TOP" up, using mounting screws provided.
6. Insert the label, attach the wall plate and restore power to the circuit.
7. Dimmer Set-up Adjustments:
  - a. **Incandescent Dimmer:** The Full ON voltage can be reduced to save energy by reducing the Full ON light level. To change the Full ON light level, slide the dimmer knob up to its full brightness. **DISCONNECT POWER FROM CIRCUIT**, and remove the wall plate. Use a small insulated, screwdriver to adjust the trim potentiometer. Turn down to decrease the Full ON light level.
  - b. **Magnetic Low Voltage Dimmer:** The minimum light level may need adjustment for variations in low voltage transformers. To change the minimum light level, slide the dimmer knob down to the lowest brightness. **DISCONNECT POWER FROM CIRCUIT**, and remove the wall plate. Use a small insulated, screwdriver to adjust the trim potentiometer. Turn down to decrease the minimum light level.

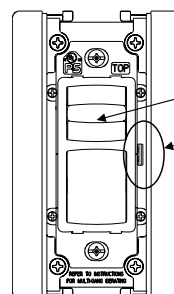
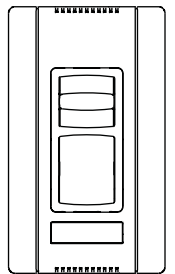

Knob

Trim Potentiometer

**NOTE: Never adjust trim potentiometer when circuit is live.**

## MULTIPLE GANGING OF DIMMERS

Any combination of dimmer models may be ganged together. Using a vise or heavy-duty pliers, remove the fins on either or both sides of the heat sink, as necessary. Dimmers can be ganged without removing fins by proper selection and placement of outlet boxes (see Table 2 and Table 3). When Dimmers are ganged, De-rate the maximum load according to the following De-Rating Table 1:

**Table 1 – Derating for Multi-Gang Installations**

	Dimmer Catalog #	1-Gang Installation	Fins are NOT Removed		Fins are Removed	
			2-Gang Installation	3- or more Gang Installation	2-Gang Installation	3- or more Gang Installation
<b>Narrow Dimmers</b>	CD700	700W	700W	700W	700W	700W
	CDLV700	700VA	700VA	700VA	700VA	700VA
	CD703P	700W	700W	700W	700W	700W
	CDLV703P	700VA	700VA	700VA	700VA	700VA
	CD1100	1100W	1100W	1000W	1000W	900W
	CDLV1100	1100VA	1100VA	1000VA	1000VA	850VA
	CD1103P	1100W	1100W	1000W	1000W	950W
<b>Wide Dimmers</b>	CDLV1103P	1100VA	1100VA	1000VA	1000VA	850VA
	CD1600	1600W	1600W	1600W	1600W	1550W
	CDLV1600	1600VA	1600VA	1600VA	1600VA	1550VA
	CD1603P	1600W	1600W	1600W	1600W	1550W
	CDLV1603P	1600VA	1600VA	1600VA	1600VA	1550VA
	CD2000	2000W	2000W	2000W	<b>NO FINS TO REMOVE</b>	
CD2003P	2000W	2000W	2000W			

### MULTI GANG INSTALLATION INSTRUCTIONS FINS ARE NOT REMOVED

**NOTE:** A 3-gang Installation of Narrow Dimmers is shown and described below. Any Combination of Wide and Narrow Dimmers will gang the same way.

1. Select the correct box size from Table 2.

**Table 2 – Wall-box Gang Requirements – FINS are NOT REMOVED**

	Narrow Dimmers						
	0	1	2	3	4	5	6
<b>Wide Dimmers</b>	0	1	1+1*	4	4+1*	7	7+1*
<b>0</b>	0	1	1+1*	4	4+1*	7	7+1*
<b>1</b>	1	3	5	6	8	9	11
<b>2</b>	4	5	7	8	10	11	13
<b>3</b>	6	8	9	11	12	14	15
<b>4</b>	9	10	12	13	15	16	-
<b>5</b>	11	13	14	16	-	-	-
<b>6</b>	14	15	-	-	-	-	-

\*Wall Box Requirements for Ganging an Even Number of Narrow Dimmers.

**4+1 set up shown below:**

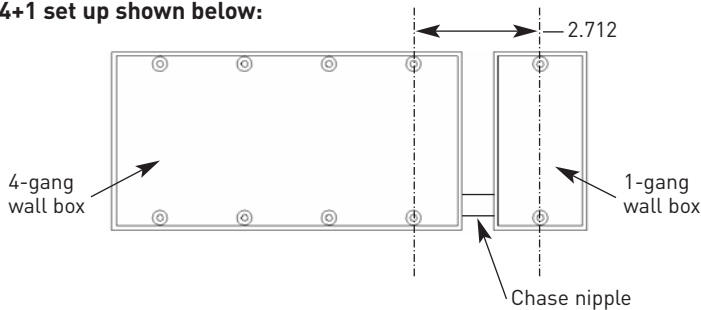

2. Remove the End Cap between adjacent dimmers (2 screws for each End Cap). Keep these screws as they will be needed at step #5.

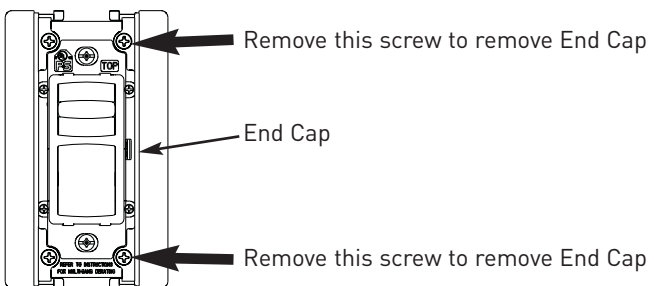

**NOTE:** The End Cap that is not between dimmers does not get removed.

3. Connect the dimmer as shown in the wiring diagram using the appropriate sized wire connectors.
4. With the word "TOP" up, install dimmer in the wall box using mounting screws provided (leave mounting screws "finger tight" at this point).

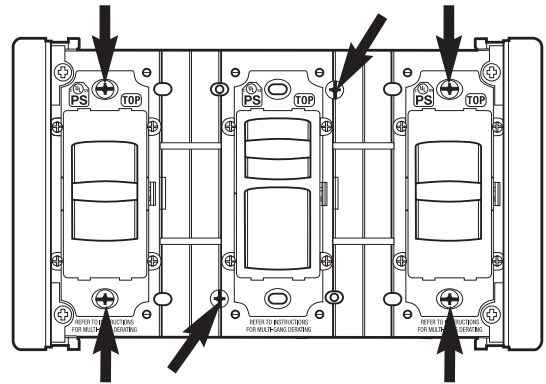

5. Attach the Couplers between the Dimmers with the screws that were removed in step 2.

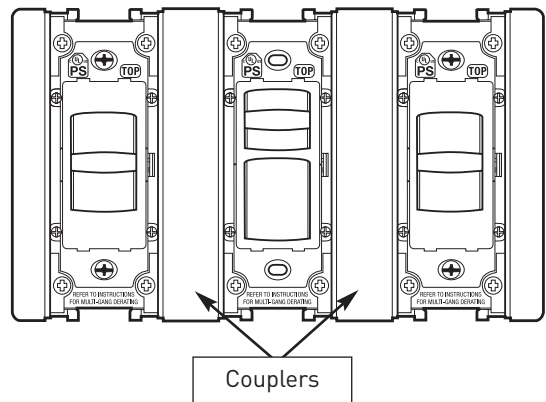

6. Tighten the mounting screws, insert the label, attach the wall plate, and restore power to the circuit.
7. Calibrate the Dimmer if necessary – Refer to Single Gang Installation Instructions, step #7.

## MULTI GANG INSTALLATION INSTRUCTIONS FINS ARE REMOVED

**NOTE:** A 3 gang Installation of Narrow Dimmers is shown and described below. Any Combination of Wide and Narrow Dimmers will gang the same way.

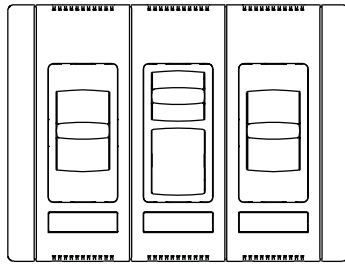

1. Select the correct box size from Table 3.

**Table 3 – Wall-box Gang Requirements – FINS are REMOVED**

Wide Dimmers		Narrow Dimmers							
		0	1	2	3	4	5	6	
0	0	1	2	3	4	5	6	7	8
1	1	3	4	5	6	7	8	9	10
2	3	4	5	6	7	8	9	10	11
3	5	6	7	8	9	10	11	12	13
4	7	8	9	10	11	12	13	14	15
5	9	10	11	12	13	14	15	16	17
6	11	12	13	14	15	16	17	18	19

2. Remove the End Cap and break the fins between adjacent dimmers [2 screws for each End Cap]. Keep these screws as they will be needed at step #5. **Note:** The End Cap and the Fins that are not between dimmers do NOT get removed.

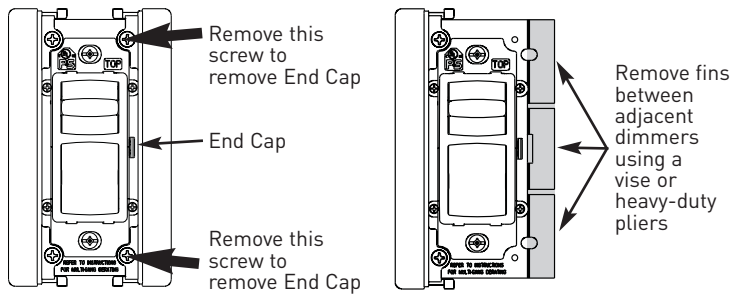

3. Connect the dimmer as shown in the wiring diagram using the appropriate sized wire connectors.
4. With the word "TOP" up, install dimmer in the wall box using mounting screws provided (leave mounting screws "finger tight" at this point).

Fins are removed between adjacent dimmers

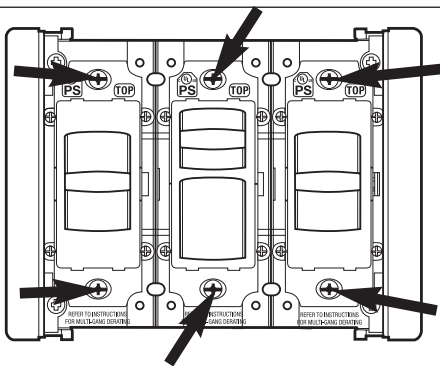

5. Attach the Small Couplers between the Dimmers with the screws that were removed in step 2.

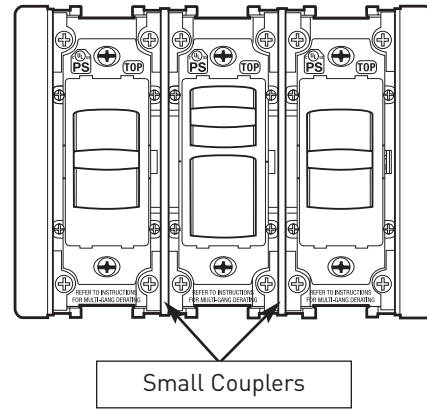

6. Tighten the mounting screws, insert the label, attach the wall plate, and restore power to the circuit.
7. Calibrate the Dimmer if necessary – Refer to Single Gang Installation Instructions, step #7.

## WARRANTIES

**Lifetime Warranty.** The device you have purchased is warranted under normal use against defects in workmanship and materials for as long as you own the device. If the device fails due to manufacturing defect during normal use, return the device for replacement to the store where purchased or send to:

Pass & Seymour Legrand  
50 Boyd Avenue  
Syracuse, NY 13209

All requests for replacement must include a dated sales receipt (legible copies acceptable).

ALL OTHER WARRANTIES, INCLUDING BUT NOT LIMITED TO ANY WARRANTIES OF MERCHANTABILITY OR FITNESS FOR A PARTICULAR PURPOSE, ARE LIMITED TO A PERIOD OF TWO YEARS FROM THE DATE OF PURCHASE. YOUR SOLE AND EXCLUSIVE REMEDY AGAINST PASS & SEYMOUR LEGRAND UNDER ANY WARRANTY SHALL BE THE EQUIVALENT REPLACEMENT OF THE DEVICE. IN NO EVENT SHALL ANY WARRANTY APPLY TO ANY DEFECT ARISING OUT OF ANY ALTERATION OF THE DEVICE, IMPROPER WIRING, IMPROPER INSTALLATION, MISUSE, ABNORMAL USE OR NEGLIGENCE. IN NO EVENT SHALL PASS & SEYMOUR LEGRAND BE LIABLE FOR LOST PROFITS, INDIRECT, SPECIAL, EXEMPLARY, INCIDENTAL OR CONSEQUENTIAL DAMAGES. Some states do not allow limitations on how long implied warranties last and do not allow exclusion or limitation of incidental or consequential damages. Some of the above limitations or exclusions may not apply to every purchaser.

**Pass & Seymour**



P.O. Box 4822, Syracuse, NY 13221-4822  
(800-223-4185)  
www.passandseymour.com

P/N 340837 Rev. B