



Pass & Seymour

# Split Circuit Receptacles PlugTail™ Devices Spec Grade 15 & 20A, 125V

PT5262SC, PT5362SC, PT26262SC, PT26362SC

**PlugTail™. The fastest,  
most consistent and reliable  
wiring devices – ever.**

The PlugTail Split Circuit device is a PlugTail duplex receptacle that can be wired for two separate circuits. These receptacles are pre-wired with a welded second hot lead to provide split circuit capability. Both duplex and Decorator style are available, and both continue to accept the standard PlugTail connector.

Factory-terminated devices and connectors mean that device installation is the same regardless of skill level of the installer. The UL-Listed connectors are keyed to ensure proper wiring installation into each receptacle. The connector simply snaps into the back of the device – no fussing with wires, stripping, or tightening screws. PlugTail devices are finger safe with no exposed terminals, so taping is not required. Now device installation is a snap!

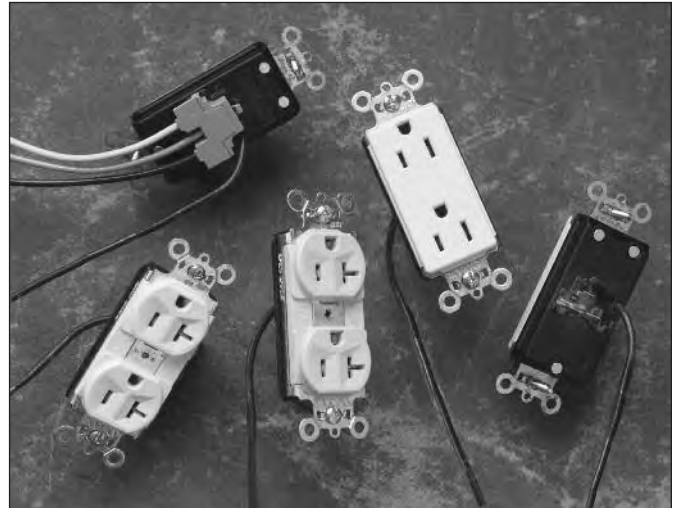

## FEATURES & BENEFITS

**Built-in connector** features large brass terminal blades to ensure consistent, reliable electrical connections.

**No exposed terminals** create a finger safe application before, during, and after installation.

**Auto-ground clip** assures positive ground.

**Large brass contacts** snugly terminate on device blade terminals. Audible snapping latch assures connection, allows release.

**.036 inch thick, brass, triple-wipe power contacts** for lasting retention.

**Ultrasonically welded polycarbonate connector housing** secures terminations and conductors in a UL Listed, finger safe housing.

**Three drive screws anchor strap** to back body and face.

**Pre-stripped connector leads** fasten to conductors, easier than standard pigtails.

PT5362SCI

**Plated steel wrap strap design** for maximum durability and corrosion resistance.

**Pre-wired with one welded pre-stripped wire lead** to facilitate switched receptacle circuit applications.

## FIELD USES/VERTICAL MARKETS

- Pre-Fabrication
- Institutional
- Hospitality/Lodging
- Multiple Dwelling

# Split Circuit Receptacles PlugTail™ Devices Spec Grade 15 & 20A, 125V

## ORDERING INFORMATION

Catalog Number	Rating		Color	NEMA Config. No.
	A.	VAC		
<b>Duplex Receptacles with 6" Lead</b>				
PT5262SCI	15	125	Ivory	5-15R
PT5262SCW	15	125	White	5-15R
PT5262SC	15	125	Brown	5-15R
PT5262SCGRY	15	125	Gray	5-15R
PT5262SCBK	15	125	Black	5-15R
PT5262SCRED	15	125	Red	5-15R
PT5262SCLA	15	125	Light Almond	5-15R
PT5262SCBL	15	125	Blue	5-15R
PT5362SCI	20	125	Ivory	5-20R
PT5362SCW	20	125	White	5-20R
PT5362SC	20	125	Brown	5-20R
PT5362SCGRY	20	125	Gray	5-20R
PT5362SCBK	20	125	Black	5-20R
PT5362SCRED	20	125	Red	5-20R
PT5362SCLA	20	125	Light Almond	5-20R
PT5362SCBL	20	125	Blue	5-20R

Catalog Number	Rating		Color	NEMA Config. No.
	A.	VAC		
<b>Decorator Receptacles with 6" Lead</b>				
PT26262SCI	15	125	Ivory	5-15R
PT26262SCW	15	125	White	5-15R
PT26262SC	15	125	Brown	5-15R
PT26262SCGRY	15	125	Gray	5-15R
PT26262SCBK	15	125	Black	5-15R
PT26262SCRED	15	125	Red	5-15R
PT26262SCLA	15	125	Light Almond	5-15R
PT26362SCI	20	125	Ivory	5-20R
PT26362SCW	20	125	White	5-20R
PT26362SC	20	125	Brown	5-20R
PT26362SCGRY	20	125	Gray	5-20R
PT26362SCBK	20	125	Black	5-20R
PT26362SCRED	20	125	Red	5-20R
PT26362SCLA	20	125	Light Almond	5-20R

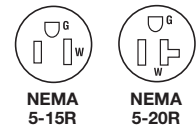

Catalog Number	Wire Type	Wire Length
<b>PlugTail Connectors – Right Angle</b>		
PTRA6SOL	Solid	6"
PTRA6STR	Stranded	6"
PTRA6SOLB25	Solid	25"
PTRA6STRB25	Stranded	25"
<b>PlugTail Connectors – Right Angle with WAGO Connectors</b>		
PTRA6SOLBP	Solid	6"
PTRA6STRBP	Stranded	6"
<b>PlugTail Connectors – Right Angle with Ground Screw</b>		
PTRA6SOLG	Solid	6"
PTRA6STRG	Stranded	6"

For more information on these and other P&S products refer to our Catalog or visit our web site.

# PlugTail™ Devices

## Split Circuit Receptacles

### Spec Grade 15 & 20A, 125V



#### TECHNICAL SPECIFICATIONS

#### 3rd Party Compliance

cULus Listed, File Number E140596, Standard UL498.  
Federal Specification WC596.  
Conforms to NEMA WD-1 and WD-6.

#### Performance

##### Electrical

Dielectric Voltage	Withstands 2000V minimum
Maximum Working Voltage	125V
Current Interrupting	Certified for current interrupting at full-rated current (receptacle only)
Temperature Rise	Maximum 30° C temperature rise at full-rated current after 50 cycles of overload at 150% of rated current with direct current

##### Mechanical

PlugTail Connector Identification	#12 AWG, THHN, copper conductor, 6" leads, stripped, solid or stranded, for use with PlugTail Receptacles only
Product Identification	Ratings are a permanent part of the device

##### Environmental

Flammability	UL92 V2
Operating Temperature	Maximum continuous +60°C to, minimum -40°C without impact

#### PlugTail Receptacle Materials

Face	Nylon	Line Contacts	.036 688 Brass
Integral Ground System	.036 260 Brass	Auto Ground Clip	Steel
Back Body	PVC	Mounting Strap	.042 Zinc-Plated Steel
Assembly Drive Screw	Zinc-Plated Steel	Mounting Screws	Tri-Drive Steel

#### PlugTail Connector Materials

Housing	Polycarbonate	Contacts	.030 Brass
---------	---------------	----------	------------

#### Warranty

1 Year

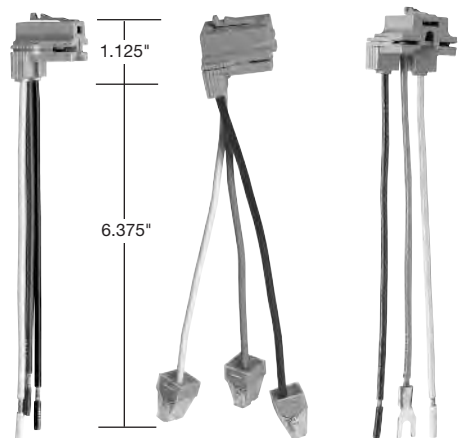
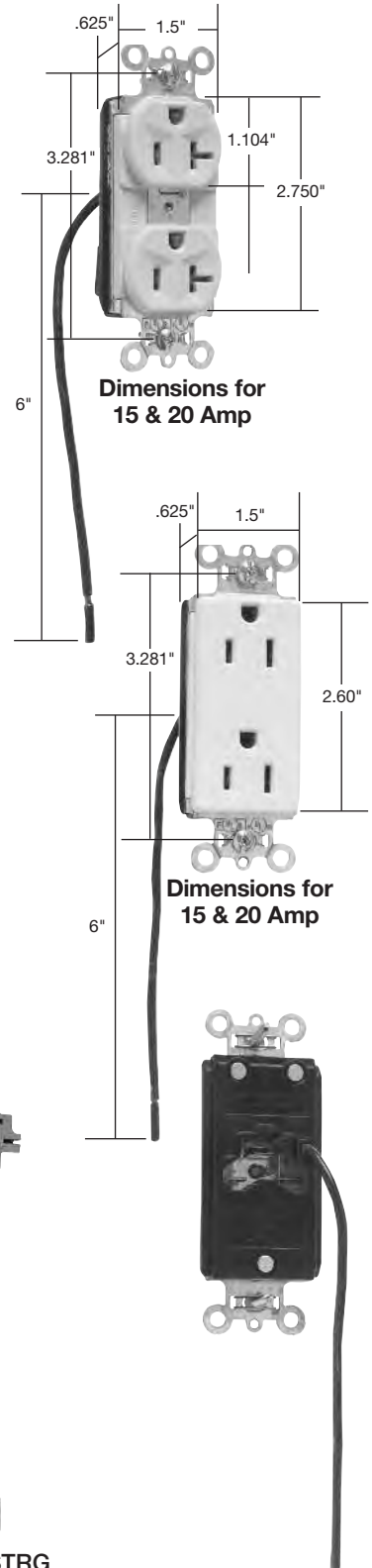

PTR6A6STR PTR6A6STRBP PTR6A6STRG

## COMPLEMENTARY DEVICES & ACCESSORIES

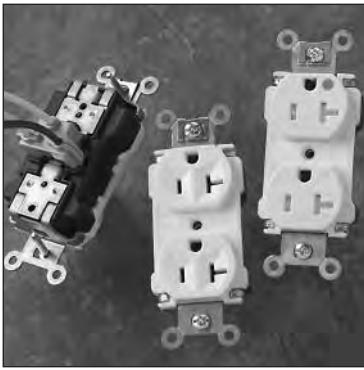

### PLUGTAIL™ DEVICES

- Extra Heavy-Duty Spec Grade
- Extra Heavy-Duty Hospital Grade
- Extra Heavy-Duty Tamper-Resistant

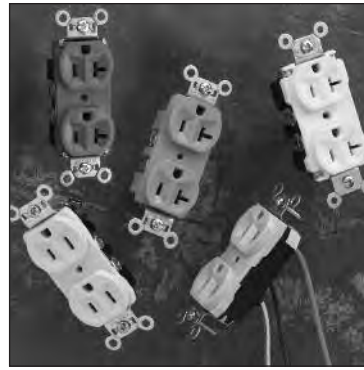

### STRAIGHT BLADE RECEPTACLES

- Extra Heavy-Duty
- Heavy-Duty
- Hard Use
- Construction Grade
- Construction Grade Leaded
- Commercial Grade

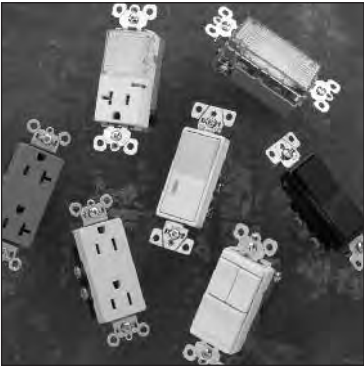

### DECORATOR DEVICES

- Construction Grade Switches
- Specification Grade Combo Switches
- Construction Grade Receptacles
- Commercial Grade Receptacles
- Specification Grade Hallway Lights

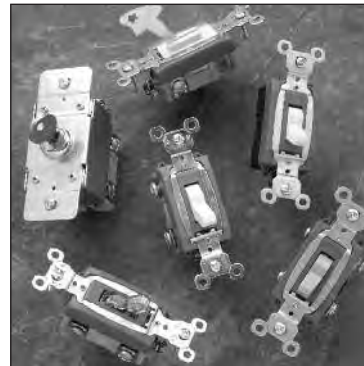

### SWITCHES

- Heavy-Duty Toggle
- Heavy-Duty Lighted Toggle
- Heavy-Duty Security
- Heavy-Duty Locking
- Construction Grade Toggle
- Commercial Grade Toggle

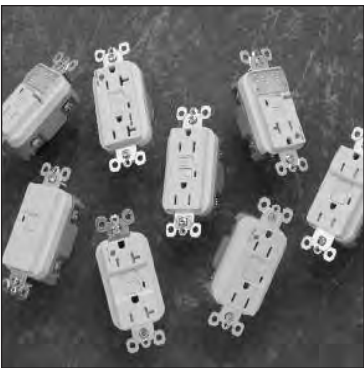

### GFCIs

- Specification Grade



### WALL PLATES

- TradeMaster® Thermoplastic Nylon
- Screwless Polycarbonate
- Stainless Steel
- Brass
- Aluminum
- Dustproof Stainless Steel Covers

## ALSO AVAILABLE...

- |                                      |                                     |                               |                            |
|--------------------------------------|-------------------------------------|-------------------------------|----------------------------|
| ■ Hospital Grade Devices             | ■ Straight Blade Plugs & Connectors | ■ Weatherproof Boxes & Covers | ■ Flexcor® Wire Mesh Grips |
| ■ TVSS & Isolated Ground Devices     | ■ Turnlok® Locking Devices          | ■ IEC 309 Industrial Products | ■ Bulk Solutions           |
| ■ Ground Continuity Monitoring (GCM) |                                     |                               |                            |



**Legrand/Pass & Seymour**  
P.O. Box 4822  
Syracuse, NY 13221-4822  
800-223-4185

**North America Headquarters**  
60 Woodlawn Street  
West Hartford, CT 06110  
Phone: 1.877.BY.LEGRAND (295.3472)  
Fax: 1.860.232.2062  
www.legrand.us

**Legrand Canada**  
570 Applewood Crescent  
Vaughan, ON, L4K 4B4  
Phone: 905.738.9195  
Fax: 905.738.9721  
www.legrand.ca

