

PASSIVE INFRARED CEILING/WALL SENSORS

CX-100 SERIES

Turns lights on and off
based on occupancy

User-adjustable time delay
and sensitivity

ASIC technology reduces components
and provides greater reliability



Choice of four coverage patterns

Built-in light level sensor

Isolated relay for use with HVAC or
other control systems

Automatic or manual-on operation
when used with a BZ-150 Power Pack

Description

Wattstopper's CX-100 Series Passive Infrared (PIR) Ceiling/Wall Sensors detect occupancy to control lighting in a wide variety of applications. These sensors provide superior coverage and performance with great energy savings.

Operation

CX-100 Series Sensors are 24 VDC and control lighting systems through Wattstopper power packs. Utilizing the latest PIR technology, they turn lights on when a difference is detected between infrared energy from a human body in motion and the background space. After the area is vacated and the time delay elapses, lighting automatically turns off.

Features

- ASIC technology reduces components and enhances reliability
- Pulse Count Processing eliminates false off without reducing sensitivity
- Detection Signature Analysis eliminates false triggers and provides immunity to RFI and EMI
- Digital time delay adjustable from 15 seconds to 30 minutes
- Adjustable sensitivity enables occupancy detection to match the level of activity for each space
- LED indicates occupancy detection
- The CX-100's integrated light level sensor can create bi-level control for added energy savings
- Multilevel Fresnel lens for superior desktop occupancy detection with four lens patterns
- Isolated relay can interface with HVAC, EMS and monitoring systems, or with an additional lighting load
- Dual-element, temperature compensated pyroelectric sensor
- Swivel mounting bracket for convenient corner mounting to wall or ceiling
- BAA/TAA-compliant models available

Coverage Choices

The CX-100 Series Sensors are available with a choice of coverage patterns. The standard lens offers coverage up to 1000 square feet for typical desktop activity. When using the CX-100/105-1 or -3 lens, motion moving toward sensors will begin to be detected at 55 to 60 feet.

Applications

The CX sensors are ideal for large areas and can cover up to 2000 square feet of walking motion. By choosing the proper lens pattern for each application, the sensors can reliably cover large offices, computer rooms, classrooms, aisleways, warehouses and open offices where coverage cut-off is desired. Corner mounting to a wall or ceiling adds versatility and more control to the coverage.

PROJECT		LOCATION/ TYPE	
---------	--	-------------------	--

Specifications

- Dual-element, temperature compensated pyroelectric sensor
- CX-100 contains isolated relay with N/O and N/C outputs; rated for 1 Amp at 24 VDC/VAC
- Adjustable time delay: 15 seconds to 30 minutes
- CX-100 integrated light level sensor: three to 200 footcandles (32 to 2,152 lux)
- Max. CX-100s per power pack: B=6, BZ=8
- Max. CX-105s per power pack: B=14, BZ=18
- Dimensions: 3.3" x 3.3" x 2.1" (83.8mm x 83.8mm x 53.3mm) W x L x D
- UL and cUL listed
- Five year warranty

Wiring & Settings

Wiring Diagram

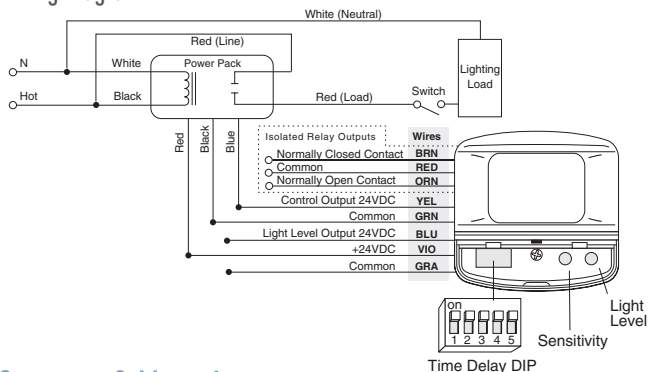

DIP Switch Settings

Time Delays	DIP Switch #				
	1	2	3	4	5
15 seconds	●	●	●	●	●
2 minutes	—	●	●	●	—
4 minutes	—	—	●	●	—
6 minutes	—	—	—	●	—
8 minutes	—	—	—	—	●
10 minutes	—	—	—	—	—
12 minutes	—	—	—	—	—
14 minutes	—	—	—	—	—
16 minutes	—	—	—	—	—
18 minutes	—	—	—	—	—
20 minutes	—	—	—	—	—
22 minutes	—	—	—	—	—
24 minutes	—	—	—	—	—
26 minutes	—	—	—	—	—
28 minutes	—	—	—	—	—
30 minutes	—	—	—	—	—
Override	—	—	—	—	●

● = on — = off ◆ = factory preset

Coverage & Mounting

Coverage Patterns

CX-100: Dense wide angle standard

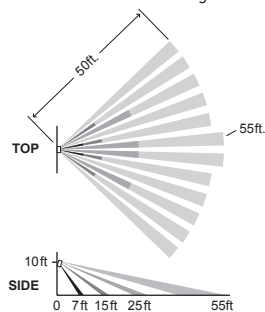

CX-100-3: Two-sided aisleway

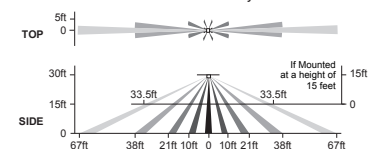

CX-100-1: Long range

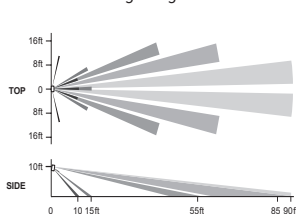

CX-100-4: One-sided aisleway

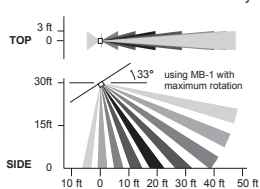

Mounting

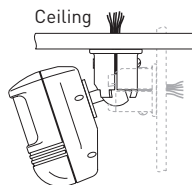

A swivel mounting bracket allows the sensor to be angled for wall or ceiling mounting. Grooves on the bracket help to achieve desired angle for coverage.

Industrial Mounting

MB-1 Industrial Mounting Bracket

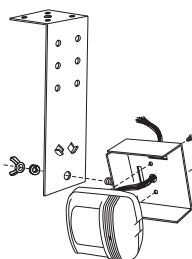

The MB-1 is used for ceiling or fixture installations in industrial settings.

Coverages shown are maximum and represent half-step walking motion. Under ideal conditions with no barriers or obstacles, coverage for half-step walking motion with the standard lens can reach up to 2000 ft², while coverage for typical desktop activity can reach up to 1000 ft². When using the CX-100/105-1 or -3 lens, motion moving toward sensors will begin to be detected at 55 to 60 feet.

Ordering Information

Catalog #	Voltage	Current	Coverage	Features
<input type="checkbox"/> CX-100	24 VDC	19 mA	up to 2000 ft ² (185.8 m ²)	isolated relay, light level
<input type="checkbox"/> CX-100-1	24 VDC	19 mA	up to 90 linear ft (27.4 m)	isolated relay, light level
<input type="checkbox"/> CX-100-3	24 VDC	19 mA	up to 120 linear ft (36.6 m)	isolated relay, light level
<input type="checkbox"/> CX-100-4	24 VDC	19 mA	up to 50 linear ft (15.2 m)	isolated relay, light level
<input type="checkbox"/> CX-105	24 VDC	8 mA	up to 2000 ft ² (185.8 m ²)	
<input type="checkbox"/> CX-105-U	24 VDC	8 mA	up to 2000 ft ² (185.8 m ²)	
<input type="checkbox"/> CX-105-1	24 VDC	8 mA	up to 90 linear ft (27.4 m)	
<input type="checkbox"/> CX-105-1-U	24 VDC	8 mA	up to 90 linear ft (27.4 m)	
<input type="checkbox"/> CX-105-3	24 VDC	8 mA	up to 120 linear ft (36.6 m)	
<input type="checkbox"/> CX-105-4	24 VDC	8 mA	up to 50 linear ft (15.2 m)	
<input type="checkbox"/> MB-1	Industrial Mounting Bracket (recommended for use with -3 and -4 lenses)			
<input type="checkbox"/> MB-2	Industrial Mounting Bracket for HID fixtures			

All units are white and use Wattstopper power packs. Current consumption can be slightly higher when only one sensor per power pack is used. -U = BAA/TAA compliant; product is compliant with Buy American Act and Trade Agreement Act