

Trenchduct Feeder System for Wallduct, Underfloor Duct, and Cellular Raceways

Wiremold® Trenchduct Feeder Systems are the first choice for infloor distribution raceways providing large capacity, easy installation and future flexibility. Trenchduct also provides for easy lay-in installation of wires and cables. The most common trenchduct application is as a feeder system for infloor raceway systems including Walkerdut® Underfloor Duct and Walkercell® Cellular Raceway. Trenchduct is used in hospitals and health care facilities as a floor feeder for Wallduct Medical Systems Raceway and can also be used as a stand alone wire management system for commercial and retail applications where ease of access and high capacity are primary concerns.



Trenchduct is installed flush in a concrete floor providing easy access to wires and cables

FEATURES & BENEFITS

- **Large capacity.** Trenchduct is designed to meet large capacity requirements for single or multiple service systems.
- **Flexible construction.** Trenchduct width, depth, number of compartments and compartment widths can be designed to meet specific job requirements.
- **Covers are relocatable to any location along the trench.** Eliminates the need to mark and reinstall cover plates in original locations.
- **Dual prepour adjustment.** Trenchduct can be leveled to the screed depth using the leveling foot or coupling up to 3/4" [19.1mm].
- **No weld construction.** Makes field modifications simple and easy.
- **Reversible tile trim supplied with standard assemblies.** Trim is reversed to expose tile trim leg eliminating the need for additional parts. Covers are painted with primer paint only and are not intended to be used without floor covering.
- **Future needs can be met without disturbance to flooring.** Simply remove cover plates to make wiring changes and additions as required.
- **cULus Listed.** Trenchduct Feeder Systems are UL Listed to U.S. and Canadian safety standards..



Trenchduct application used as a feeder system for Walkercell Cellular Raceway.

Trenchduct Feeder Systems Product Details

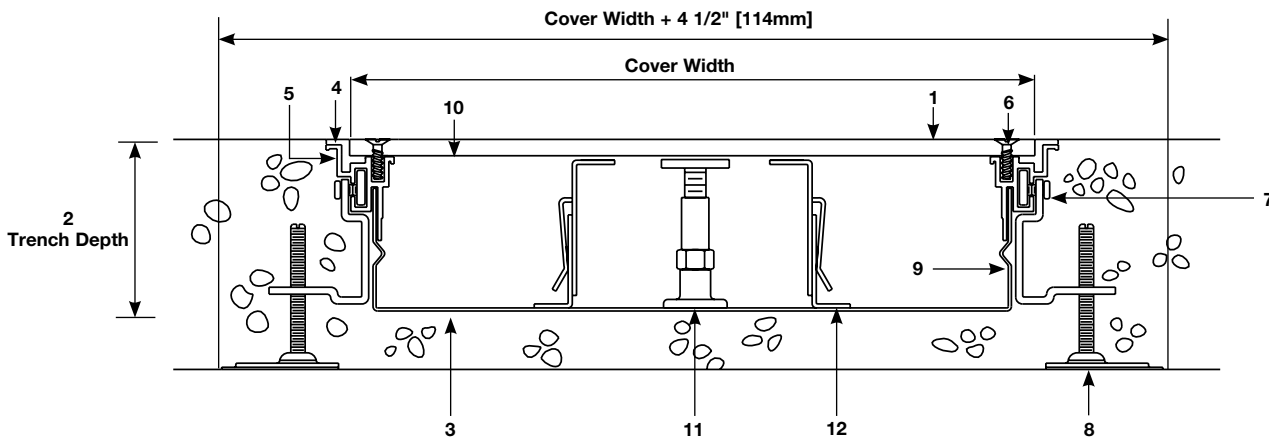

NOTES: Vinyl reversible tile trim included.
 Covers are not intended to be used without floor covering. Trenchduct covers are painted with primer paint only and are not meant to act as a finished surface.
 Interior width of trenchduct body is always 13/16" [21mm] less than cover plate.
 Interior depth of trenchduct body is always 5/16" [7.9mm] less than depth described by catalog number.

STANDARD PRODUCT			MTO
1	COVER	Width	6" [152mm]; 12" [305mm]; 18" [457mm]; 24" [610mm]
		Thickness	1/4" [6.4mm]
		Material	Painted Steel Plate
2	Depth	2 1/2" [64mm] or 3 1/4" [83mm]	Select Sizes up to 36" [915mm]; 3/8" [9.5mm]
3	Body Material	16 Gauge Galvanized Steel	14 Gauge Galvanized Steel Aluminum
4	Trim	Extruded Vinyl for 1/4" [6.4mm] Plate	Vinyl for 3/8" [9.5mm], Aluminum for 1/4" [6.4mm] or 3/8" [9.5mm] Plate
5	Side Rail	Extruded Aluminum for 1/4" [6.4mm] Plate	Extruded Aluminum for 3/8" [9.5mm] Plate
6	Hold-Down Screw	#10 x 5/8" [15.9mm] Flathead Stainless Steel Plastite	Same
7	Combination Clip Assembly	12 Gauge Galvanized 2" [51mm] Long	Same
8	Leveling Foot	5/16 - 18 x 2" [51mm] Long	*Up to 4" [102mm] long
9	Steel Side Rail	16 Gauge Galvanized Steel	14 Gauge Galvanized Steel
10	Lap Strip Gasket	1/32" [.8mm] Polylofin	Same
11	Support Post	6" [152mm] or 12" [305mm] On Center Strips 5' [1.5m] Long; Required if Unsupported Cover Plate Width Exceeds 18" [457mm] Maximum Span for 1/4" [6.4mm] Plate	As Required for Strength Factory Installed
12	Partition	Adjustable - Clip Lanced into Top Partition, Field Installed	Bolt - Type Partition, Factory Installed; U-Channel Partition, Factory Installed

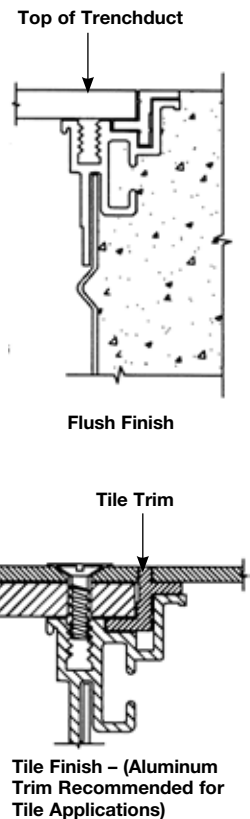

*For Trenchduct orders deeper than 4" please use a wooden block to support the leveling foot and bring it up to the correct height.

NOTE: Aluminum trim available for 1/4" [6.4mm] plate and is recommended for tile applications.

TRENCHDUCT LOAD CAPACITIES (LBS)						
COVER PLATE THICKNESS	LOAD TYPE	TRENCHDUCT WIDTH				
		6" [152MM] NO SUPPORTS	12" [305MM] NO SUPPORTS	18" [457MM] ONE ROW SUPPORTS	24" [610MM] ONE ROW SUPPORTS	36" [914MM] TWO ROW SUPPORTS
1/4" [6.4mm]	Concentrated	1300	1300	1300	800	1200
1/4" [6.4mm]	Rolling	800	840	800	500	780
3/8" [9.5mm]	Concentrated	2400	2400	2400	2000	2000
3/8" [9.5mm]	Rolling	1500	1560	1500	1300	1300

Trenchduct Feeder Systems Components Ordering Information

Catalog No./Item

VA12W250H-1
 VA12W250H-2
 VA12W250H-5
 VA12W250H-6
 VA12W325H-1
 VA12W325H-2
 VA12W325H-5
 VA12W325H-6

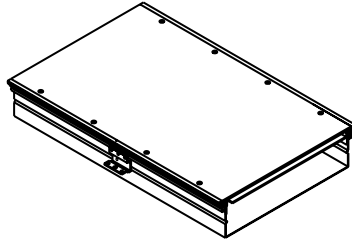

Description/Specifications

Body and Cover Assembly – Flush floor raceway with removable cover plates. Cover plate is 1/4" [6.4mm] thick and three pieces are supplied for 5' [1.5m] and 6' [1.8m] lengths (5' cover is two 24" and one 12" sections and 6' cover is three 24" sections). Partitions and supports not included. Length, width, and depth described in catalog number represent outside cover plate and body dimensions. The interior size of the trenchduct bodies is always 13/16" [21mm] narrower than the cover plate. The interior depth of the trenchduct bodies is always 5/16" [7.9mm] shallower than depth specified by catalog number. Body is 16 gauge steel. Vinyl trim and leveling feet are included. Can be leveled to screed depth using leveling foot or support coupling up to 3/4" [19.1mm]. Use catalog numbering system to select product. Consult Wiremold® sales representative for custom sizes.

Catalog Number System

VA 12W 250H - 1

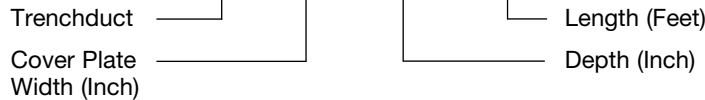

Standard Selection Options:

Cover Plate Width = 6", 12", 18", or 24"
 [152mm, 305mm, 457mm, or 610mm]
Depth = 250 or 325 (2 1/2" or 3 1/4" [64mm or 83mm])
Length = 1', 2', 5', or 6' [.3m, .6m, 1.5m, or 1.8m]

See "Trenchduct Product Selection" information on page 7 to assist in determining appropriate product for application.

NOTE: For other widths substitute cover plate width in above catalog numbers with 12, 18, or 24.

NOTE: Covers are not intended to be used without floor covering. Trenchduct covers are painted with primer paint only and are not meant to act as a finished surface.

T250HZP-5
 T325HZP-5

2 1/2" [64mm] Depth
 3 1/4" [83mm] Depth

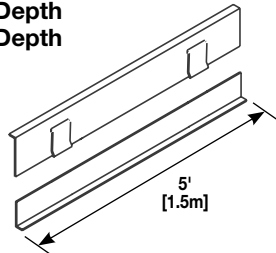

Adjustable Partition – Used to separate trenchduct and fitting into two or more compartments. Allow 3/4" [19.1mm] upward adjustment. Field installed to base of trenchduct with welds or screws. Available in 5' [1.5m] length. Field modified for use in T-Units, risers, and elbows.

VA06SSS250-5
 VA06SSS325-5

(6" [152mm] O.C. 2 1/2" [64mm] D)
 (6" [152mm] O.C. 3 1/4" [83mm] D)

VA12SSS250-5
 VA12SSS325-5

(12" [305mm] O.C. 2 1/2" [64mm] D)
 (12" [305mm] O.C. 3 1/4" [83mm] D)

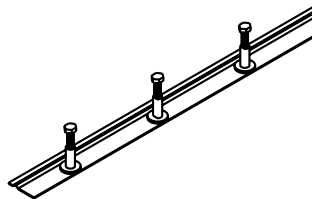

Support Strips – Used to provide strength to support cover plate. Required for clear spans of 16" [406mm] or greater, or any trench wider than 18" [457mm], without partitions or when heavy loads will be used such as in casinos. Available in 6" or 12" [152mm or 305mm] on center bolt spacing. 12" [305mm] O.C. spacing is adequate for most applications. Select 6" [152mm] O.C. spacing for heavy loads. Support bolts should be located 2" [51mm] from ends of cover plates. Strip is field installed to base of trenchduct with welds or screws. Available in 5' [1.5m] lengths.

VA06W250HEC
 VA06W325HEC

VA12W250HEC
 VA12W325HEC

VA18W250HEC
 VA18W325HEC

VA24W250HEC
 VA24W325HEC

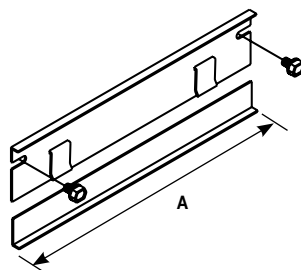

End Closure – Used to close off end of trenchduct. Two-piece design allows 3/4" [19.1mm] vertical adjustment. "A" dimension is trenchduct width.

Trenchduct Feeder Systems Components Ordering Information (Continued)

Catalog No./Item

Description/Specifications

VA250PEC-LH3
VA250PEC-RH3

VA325PEC-LH3
VA325PEC-RH3

VA250PEC-LH6
VA250PEC-RH6

VA325PEC-LH6
VA325PEC-RH6

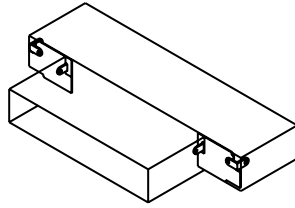

Partial End Closure Reducer – Used to reduce trenchduct from one piece to the next in a linear direction. Order left or right side in widths of 3" [76mm] or 6 [152mm]

VA06W250H-T
VA06W325H-T

VA12W250H-T
VA12W325H-T

VA18W250H-T
VA18W325H-T

VA24W250H-T
VA24W325H-T

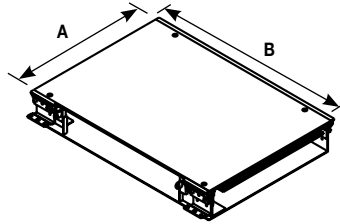

T-Unit – Used to connect intersecting runs of trenchduct at 90° angles on three sides. Length, width, and depth specified by catalog number. Closed side is length. Use partition or tunnel to separate services (ordered separately for standard product).

A	6" [152mm]	12" [305mm]	18" [457mm]	24" [610mm]
B	12" [305mm]	18" [457mm]	24" [610mm]	30" [762mm]

VAT12W250H3CT
VAT12W325H3CT

VAT18W250H3CT
VAT18W325H3CT

VAT24W250H3CT
VAT24W325H3CT

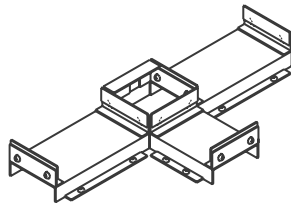

T-Unit Tunnel – Used to separate three services within T-Unit. Field attached with screws or welds.

See chart for width of power compartment. Not available for 6" [152mm] wide trenchduct.

TRENCH WIDTH	12" [305mm]	18" [457mm]	24" [610]
POWER CHANNEL WIDTH	3 1/2" [89mm]	4" [102mm]	5" [127mm]

VA06W250H-X
VA06W325H-X

VA12W250H-X
VA12W325H-X

VA18W250H-X
VA18W325H-X

VA24W250H-X
VA24W325H-X

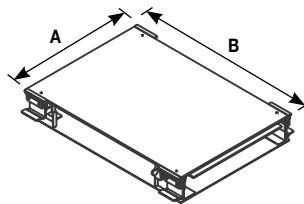

X-Unit – Used to connect intersecting runs of trenchduct at 90° angles on all four sides. Length, width, and depth specified by catalog number. Use tunnel and partition as needed to separate services (ordered separately for standard product).

A	6" [152mm]	12" [305mm]	18" [457mm]	24" [610mm]
B	12" [305mm]	18" [457mm]	24" [610mm]	30" [762mm]

Trenchduct Feeder Systems Components Ordering Information (Continued)

Catalog No./Item

VAT12W250H3CX
VAT12W325H3CX

VAT18W250H3CX
VAT18W325H3CX

VAT24W250H3CX
VAT24W325H3CX

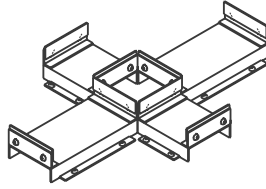

Description/Specifications

X-Unit Tunnel – Used to separate three services within X-Unit. Field attached to base of trenchduct with screws or welds.

See chart for width of power compartment.
Not available for 6" [152mm] wide trenchduct.

TRENCH WIDTH	12" [305mm]	18" [457mm]	24" [610]
POWER CHANNEL WIDTH	3 1/2" [89mm]	4" [102mm]	5" [127mm]

VA06W250H-RL
VA06W325H-RL

VA12W250H-RL
VA12W325H-RL

VA18W250H-RL
VA18W325H-RL

VA24W250H-RL
VA24W325H-RL

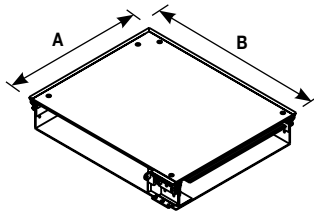

Right Hand Horizontal Elbow – Used to change direction of trenchduct run 90° to the right. Length, width, and depth specified by catalog number. Use partition to separate services (ordered separately for standard product).

A	6" [152mm]	12" [305mm]	18" [457mm]	24" [610mm]
B	9" [229mm]	15" [381mm]	21" [533mm]	27" [686mm]

VA06W250H-LL
VA06W325H-LL

VA12W250H-LL
VA12W325H-LL

VA18W250H-LL
VA18W325H-LL

VA24W250H-LL
VA24W325H-LL

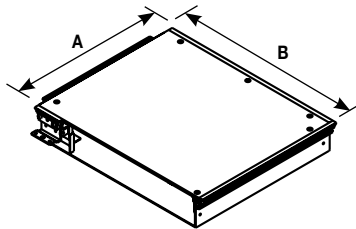

Left Hand Horizontal Elbow – Used to change direction of trenchduct run 90° to the left. Length, width, and depth specified by catalog number. Use partition to separate services (ordered separately for standard product).

A	6" [152mm]	12" [305mm]	18" [457mm]	24" [610mm]
B	9" [229mm]	15" [381mm]	21" [533mm]	27" [686mm]

VAT12W250H4CT
VAT12W325H4CT

VAT18W250H4CT
VAT18W325H4CT

VAT24W250H4CT
VAT24W325H4CT

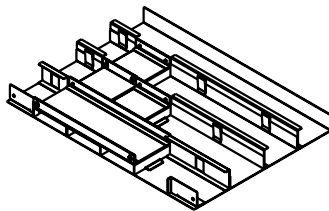

4 Compartment Fitting Tunnel – Used to divide services into 4 equal compartments. Field attached with screws or welds. Order one set for T-Unit and two sets for X-Unit. Not available for 6" [152mm] wide Trenchduct. Fittings purchased separately.

Trenchduct Feeder Systems Components Ordering Information (Continued)

Catalog No./Item

Description/Specifications

VA06W250H-L45
VA06W325H-L45

VA12W250H-L45
VA12W325H-L45

VA18W250H-L45
VA18W325H-L45

VA24W250H-L45
VA24W325H-L45

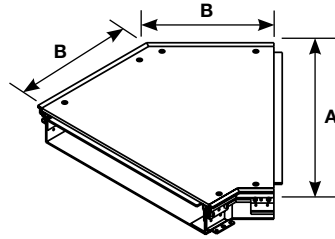

A	6" [152mm]	12" [305mm]	18" [457mm]	24" [610mm]
B	5" [127mm]	7 1/2" [191mm]	10" [254mm]	12 1/2" [318mm]

45° Mitered Horizontal Elbow – Used to change direction of trenchduct run 45° in either direction. Length, width, and depth determined by the catalog number. Use partition to separate services (ordered separately for standard product).

VA06W-VL
VA12W-VL10*
VA18W-VL
VA24W-VL

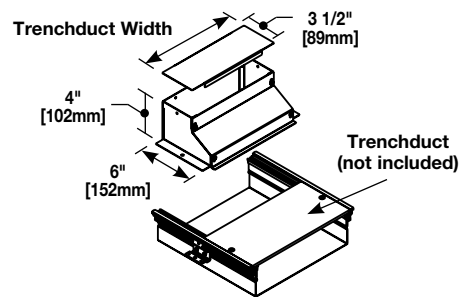

Sweep Vertical Riser – Used to transition from trenchduct into perpendicular run of Wallduct or into riser to panel. Includes removable cover plate.

***IMPORTANT!**

12" [305mm] Wide Rises to 10" [254mm] Wide to Attach to Wallduct.

VA06W-VR
VA12W-VR10*
VA18W-VR
VA24W-VR

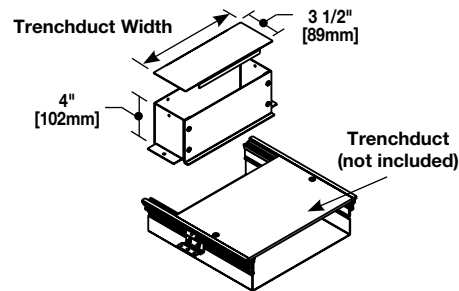

Straight Vertical Riser – Used to transition from trenchduct into perpendicular run of Wallduct or into riser to panel. Use partition to separate services (ordered separately for standard product).

***IMPORTANT!**

12" [305mm] Wide Rises to 10" [254mm] Wide to Attach to Wallduct.

VA06W-AH3
VA12W-AH3
VA18W-AH3
VA24W-AH3

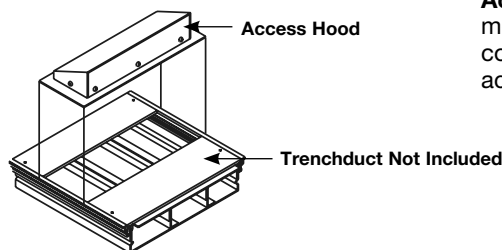

Access Hood – Service fitting can be mounted on trenchduct in place of the cover plate. Removable back plate allows access into the trenchduct body.

485

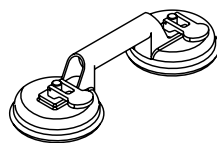

Cover Plate Lifter – Used to assist in removing cover plates from trenchduct.

Trenchduct Intersection Details

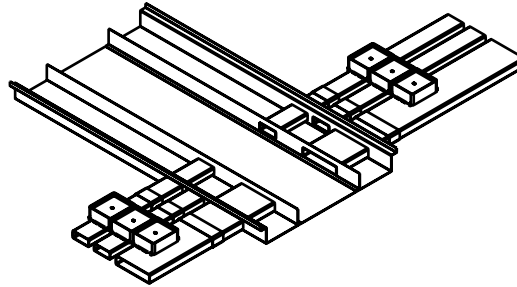

Trenchduct Side Feed into [®]Walkerduct Pro Series

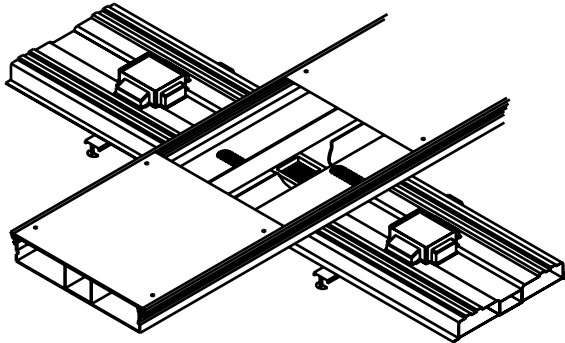

Trenchduct Crossunder Feed into Walkercell

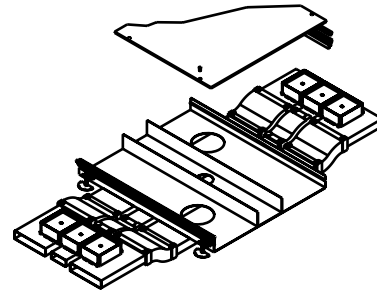

Trenchduct Crossunder Feed into Walkerduct Pro Series

Trenchduct Product Selection

Cable Size Chart

	DIAMETER		AREA (IN ²)	
	IN.	MM	SQ. IN.	SQ. MM
UNSHIELDED TWISTED PAIR				
4-PAIR, CAT 5	.220	[5.6]	.038	[24.5]
4-PAIR, CAT 6	.250	[6.4]	.049	[31.7]
TELEPHONE				
2-PAIR, 24 AWG	.140	[3.5]	.015	[9.9]
4-PAIR, 24 AWG	.190	[4.8]	.028	[18.1]
25-PAIR, 24 AWG	.410	[10.4]	.132	[85.2]
COAXIAL				
RG58/U	.195	[4.9]	.030	[19.4]
RG59/U	.242	[6.1]	.046	[29.7]
RG6/U	.270	[6.8]	.057	[36.8]
SHIELDED TWISTED PAIR				
TYPE 1	.390	[9.9]	.119	[76.8]
TYPE 2	.465	[11.8]	.170	[109.7]
TYPE 3	.245	[6.2]	.047	[30.3]
FIBER OPTIC				
2-STRAND	.180	[4.6]	.025	[16.1]
4-STRAND	.190	[4.8]	.028	[18.1]
6-STRAND	.210	[5.3]	.035	[22.6]
FIBER ZIP CORD	.110	[2.8]	.010	[6.5]

Wire Size Chart

WIRE SIZE AWG	DIAMETER		AREA (IN ²)	
	IN.	MM	SQ. IN.	SQ. MM
14	.111	[2.8]	0.010	[6.5]
12	.130	[3.3]	0.013	[8.4]
10	.164	[4.1]	0.021	[13.5]
8	.216	[5.4]	0.037	[23.9]
6	.254	[6.4]	0.051	[32.9]
4	.324	[8.2]	0.082	[52.9]

Steps to Select Trench Size:

1. Determine types and quantities of cables and wires needed.
2. Use wire and cable size charts to calculate sq. in. capacity needed for all wires and cables. For products not listed, consult manufacturers of wire/cable for specifications.
3. Compare total capacity needed to trench capacity table below to select appropriate trench size.

NOTE: 40% cable fill is the maximum cable fill allowed by NEC. Capacities at Ts or tunnels will be less than 40%.

Trench Capacity Chart

WIDTH		DEPTH		TOTAL CAPACITY	
IN.	MM	IN.	MM	SQ. IN.	SQ. MM
6	[152]	2 1/2	[64]	11.1	7161
12	[305]	2 1/2	[64]	24.1	15548
18	[457]	2 1/2	[64]	37.2	24000
24	[610]	2 1/2	[64]	50.3	32452
6	[152]	3 1/4	[83]	14.9	9613
12	[305]	3 1/4	[83]	32.5	20968
18	[457]	3 1/4	[83]	50.1	32323
24	[610]	3 1/4	[83]	67.7	43677

NOTES



Electrical Wiring Systems

60 Woodlawn Street
West Hartford, CT 06110
Phone: 1.877.BY.LEGRAND (295-3472)
www.legrand.us

570 Applewood Crescent
Vaughan, Ontario L4K 4B4
Phone: 905.738.9195
www.legrand.ca

