

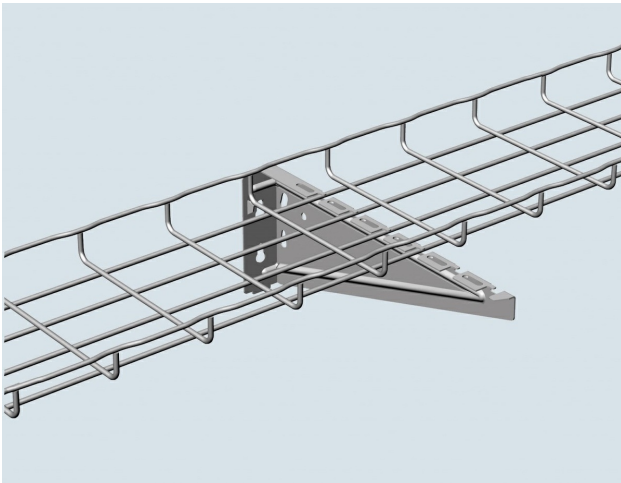

Cablofil
FASUCB600GC FAS UNIVERSAL BRACKET 350873
Part No. 350873



Cablofil Wiremesh Cable Tray concept based upon performance, safety and economy; three qualities which make Cablofil Wiremesh Cable Tray system preferred by installers. Cablofil adapts to the most complex configurations, and its structure gives maximum strength for minimum weight. The ease of creating fittings, carried out on site, as well as the wide range of unique and universal accessories gives complete freedom in routing combined with exceptionally fast installation.

Features & Benefits

Use for tray support in under floor application in combination with EDF Rail. Use patented locking tabs on FAS U to secure tray without additional hardware. Supports wider tray and heavier loads than FAS L. FAS U snaps directly into EDF rail.

Specifications

General Info

Product Line	Cablofil	Finish	Hot Dipped Galvanized
UPC Number	800388003330	Country Of Origin	France

Dimensions

Product Width US	1.654 in	Product Weight US	2.725 lb
Product Volume US	0.13 cu ft	Product Depth US	24.99 in
Product Height US	5.44 in		

Buy American Act Compliance

BAA	Yes
-----	-----

Additional Information

RoHS Conformant	Yes
-----------------	-----