

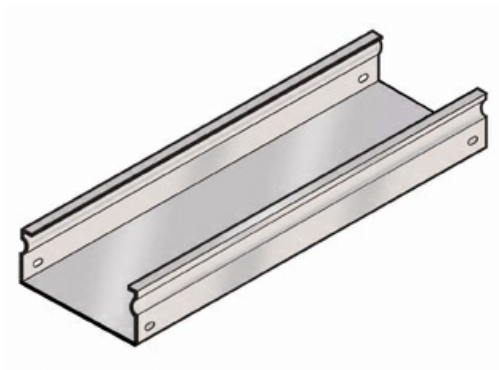

Cablofil
New FT50/50PG - FiberTrough Straight
Part No. 480020



Cablofil Fiber Trough utilizes high strength steel components to provide the strength and durability required to manage fiber cabling requirements in the most demanding data center environments.

Features & Benefits

Built in splicing for connection without separate splice plates.

Strong corrosion resistant steel construction.

Specifications

General Info

Product Line	Cablofil	Finish	Pre-Galvanized
UPC Number	800388240049	Country Of Origin	Italy

Dimensions

Product Width US	2.0 in	Product Weight US	5.527 lb
Product Volume US	0.272 cu ft	Product Depth US	117.6 in
Product Height US	2.0 in		