

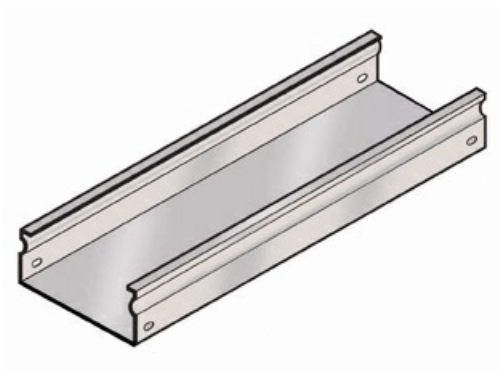

Cablofil
FiberTrough Straight- PAINTED (4H,12W)
Part No. 960549



Cablofil Fiber Trough utilizes high strength steel components to provide the strength and durability required to manage fiber cabling requirements in the most demanding data center environments.

Features & Benefits

Strong corrosion resistant steel construction.

Rolled Edge: for cable protection.

Unique Design: allows cover to snap on.

18 gage steel (t).

Specifications

General Info

Product Line	Cablofil	Finish	Custom Painted
Country Of Origin	Italy		

Dimensions

Product Weight US	29.813 lb
-------------------	-----------

Buy American Act Compliance

BAA	Yes
-----	-----