

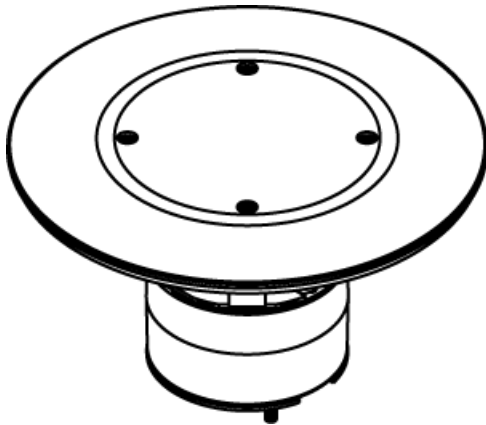

Wiremold
Abandonment Plug Assembly for 3" cored hole
Part No. ABPLUG3



Flush Style Poke-Thru Devices are an excellent solution for bringing power, communication, and A/V services to the workstation in an open space, above-grade floor environment. All Wiremold Flush Style Poke-Thru Devices come with built-in TopGuard™ protection, an industry-leading design that meets and exceeds UL scrub water exclusion requirements for tile and carpet floors. Topguard protection prevents water, dirt, or debris from entering not just the power devices, but also the communication devices. All Wiremold Flush Style Poke-Thru Devices can be installed on tile, carpet, or wood covered floors. Each of these devices provides an excellent solution for both new or retrofit construction, with typical applications that include office buildings, airports, malls, shopping centers, libraries, and schools.

Features & Benefits

Complete plug assembly for abandoning an open 3" (76mm) diameter hole. Assembly includes intumescent fire-stop material to maintain the fire-classification of the floor, integral retainer ring to prevent the unit from pulling up through the floor, and a black die-cast aluminum cover.

Specifications

General Info

Product Line	Wiremold	UPC Number	786564029274
Country Of Origin	Mexico	Construction	Assembled
Application Sector	Commercial	Standard	cULus Listed Metallic Outlet Boxes: File E2961 Guide QCIT. cULus Listed Nonmetallic Outlet Boxes & Fittings Classified for Fire Resistance: File R8209 Guide CEYY. Meets Article 300.21, 300.22[C] & 314 of NEC.
Type	Poke-Thru		

Buy American Act Compliance

NAFTA	Yes
-------	-----

Additional Information

RoHS Conformant	Yes
-----------------	-----