

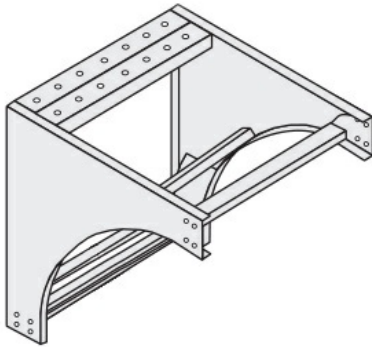

**Cablofil**  
**Vertical Support Elbow**  
Part No. P037630



Choose from an extensive selection of metallic ladder tray with a variety of rung and bottom styles to choose from. Finishes include steel, 304L and 316L stainless steel to meet the needs of any application. Rail heights range from 4" to 7" and width sizes are available up to 36".

## Features & Benefits

---

Splices included

## Specifications

---

### General Info

---

Product Line	Cablofil	Finish	GC
UPC Number	800388407428	Country Of Origin	Mexico

---

### Dimensions

---

Product Width US	10.5 in	Product Weight US	50.451 lb
Product Volume US	13.423 cu ft	Product Depth US	47.0 in
Product Height US	47.0 in		

---

### Buy American Act Compliance

---

BAA	Yes
-----	-----

---