

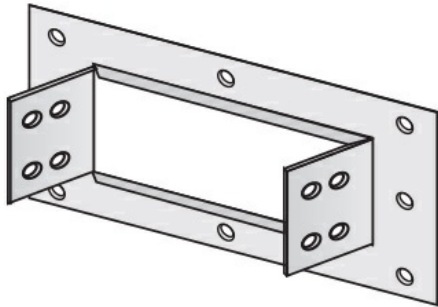

Cablofil
Tray-To-Box Connector, Frame Type
Part No. P087244

Finishes include steel and 316L stainless steel to meet the needs of any application. Rail heights range from 4" to 7".



Features & Benefits

All splices are supplied in pairs.

Geomet fasteners are standard on aluminum and steel cable tray systems.

Type 316 stainless steel fasteners are standard on stainless steel systems, but are available as an option on all aluminum and steel systems.

Sufficient connector pairs with fasteners are automatically included with each shipment of straight sections and fittings. Extras for field cuts or spares must be ordered separately.

Bonding jumpers are required for all expansion splice plates, adjustable connectors, and tray discontinuities.

Specifications

General Info

Product Line	Cablofil	Finish	Hot Dipped Galvanized
UPC Number	800388392946	Country Of Origin	Mexico

Dimensions

Product Width US	13.0 in	Product Weight US	1.592 lb
Product Volume US	0.298 cu ft	Product Depth US	3.375 in
Product Height US	6.5 in		

Buy American Act Compliance

BAA	Yes
-----	-----