

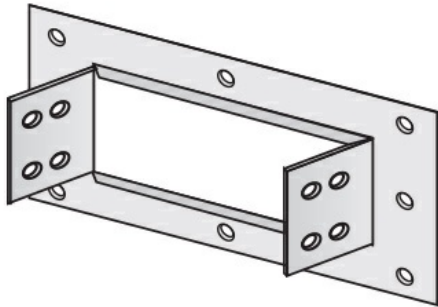

Cablofil  
Tray-To-Box Connector, Frame Type  
Part No. P087246

Finishes include steel and 316L stainless steel to meet the needs of any application. Rail heights range from 4" to 7".



## Features & Benefits

All splices are supplied in pairs.

Geomet fasteners are standard on aluminum and steel cable tray systems.

Type 316 stainless steel fasteners are standard on stainless steel systems, but are available as an option on all aluminum and steel systems.

Sufficient connector pairs with fasteners are automatically included with each shipment of straight sections and fittings. Extras for field cuts or spares must be ordered separately.

Bonding jumpers are required for all expansion splice plates, adjustable connectors, and tray discontinuities.

## Specifications

### General Info

Product Line	Cablofil	Finish	Hot Dipped Galvanized
UPC Number	800388392960	Country Of Origin	Mexico

### Dimensions

Product Width US	16.0 in	Product Weight US	1.77 lb
Product Volume US	0.367 cu ft	Product Depth US	3.375 in
Product Height US	6.5 in		

### Buy American Act Compliance

BAA	Yes
-----	-----