

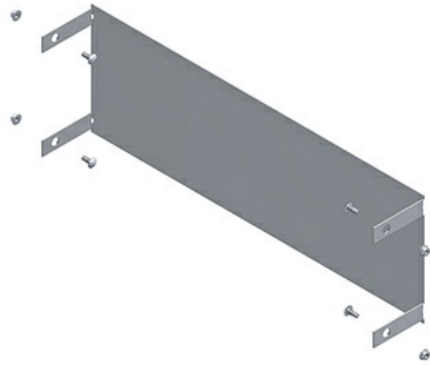

Cablofil  
Blind End Kit  
Part No. P314454



The aluminum I-beam design of ITray is perfect for industrial installations with large diameter cables in long span situations, minimizing total tray width and creating a smooth transition between straight sections and fittings. A structural offset in the sidewall creates strong, mid-span splices that need fewer supports. Each splice snaps in place and stays without holding. Additionally, only four bolts are needed for each splice reducing hardware needs by 50%. These features allow Itray to be installed up to 30% faster than standard tray.

## Features & Benefits

Material: Aluminum Alloy 5052 - H32

Finish: Plain

Height (H): Tray height: 4", 5", 6", 7"

Width (W): Tray width: 6", 9", 12", 18", 24", 30", 36"

Torque: 19 - 25 ft-lbs

## Specifications

### General Info

Product Line	Cablofil	Finish	Aluminum
UPC Number	800388203310	Country Of Origin	Mexico

### Dimensions

Product Width US	36.0 in	Product Weight US	1.404 lb
Product Volume US	0.286 cu ft	Product Depth US	2.75 in
Product Height US	5.0 in		

### Buy American Act Compliance

BAA	Yes
-----	-----