

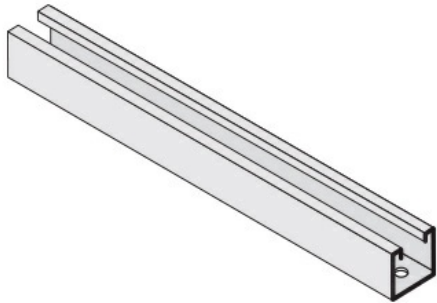

Cablofil  
Single Hanger Channel  
Part No. P602293



The aluminum I-beam design of ITray is perfect for industrial installations with large diameter cables in long span situations, minimizing total tray width and creating a smooth transition between straight sections and fittings. A structural offset in the sidewall creates strong, mid-span splices that need fewer supports. Each splice snaps in place and stays without holding. Additionally, only four bolts are needed for each splice reducing hardware needs by 50%. These features allow Itray to be installed up to 30% faster than standard tray.

## Features & Benefits

Made from 12-gauge strut

Hangers have 9/16" diameter holes 13/16" from each end to accept 1/2" threaded rod

When used with Z-type hold-down clamps, select hanger with flange out dimensions

## Specifications

### General Info

Product Line	Cablofil	Finish	Stainless 316
UPC Number	800388525535	Country Of Origin	Mexico

### Dimensions

Product Weight US	2.67 lb	Product Depth US	16.0 in
-------------------	---------	------------------	---------

### Buy American Act Compliance

BAA	Yes
-----	-----