

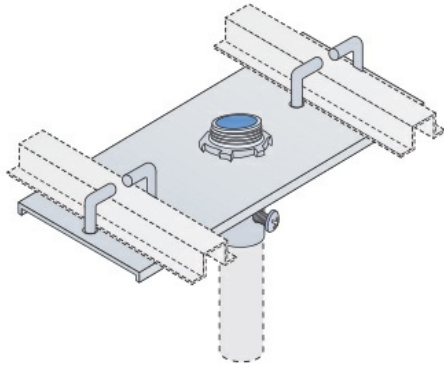

Cablofil
Conduit Plate Clamp
Part No. P606690



The aluminum I-beam design of ITray is perfect for industrial installations with large diameter cables in long span situations, minimizing total tray width and creating a smooth transition between straight sections and fittings. A structural offset in the sidewall creates strong, mid-span splices that need fewer supports. Each splice snaps in place and stays without holding. Additionally, only four bolts are needed for each splice reducing hardware needs by 50%. These features allow Itray to be installed up to 30% faster than standard tray.

Features & Benefits

Conduit clamps are purchased separately.

Specifications

General Info

Product Line	Cablofil	Finish	Pre-Galvanized
UPC Number	800388527829	Country Of Origin	Mexico

Dimensions

Product Width US	14.5 in	Product Weight US	0.894 lb
Product Volume US	0.076 cu ft	Product Depth US	1.65 in
Product Height US	5.5 in		

Buy American Act Compliance

BAA	Yes
-----	-----