

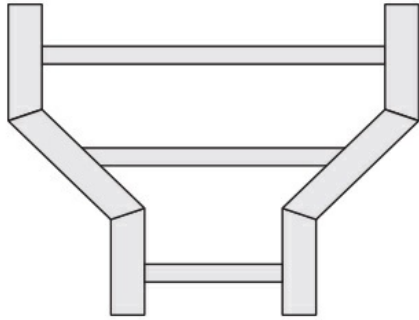

**Cablofil**  
**Horizontal Reducing Cross**  
Part No. P644709



Choose from an extensive selection of metallic ladder tray with a variety of rung and bottom styles to choose from. Finishes include steel, 304L and 316L stainless steel to meet the needs of any application. Rail heights range from 4" to 7" and width sizes are available up to 36".

## Features & Benefits

Includes splices and hardware

## Specifications

### General Info

Product Line	Cablofil	Finish	AL
UPC Number	800388473140	Country Of Origin	Mexico

### Dimensions

Product Width US	48.0 in	Product Weight US	14.832 lb
Product Volume US	7.844 cu ft	Product Depth US	39.0 in
Product Height US	7.241 in		

### Buy American Act Compliance

BAA	Yes
-----	-----