

## Activations for Every Application!

Walkerduct Pro Series Service Fittings offer a complete range of service fittings to meet all power, data and communication requirements. The flush flanges with interchangeable covers provide an aesthetic appearance that will please any architect or building owner. These flush service fittings are available in brushed aluminum, brass and nonmetallic finishes for single-, double- and triple-duct runs. Fittings are available for feeding directly out of the underfloor duct preset while keeping the connections to a minimum visibility. These metal covers fit directly over the preset and provide a simple and effective activation. When a traditional pedestal service fitting is preferred, the 525 Series and the Multiplex™ Series Service Fittings can be mounted on the preset opening. All service fittings are UL Listed to U.S. and Canadian safety standards. These activations are ideal for retail stores, schools, casinos and office buildings.

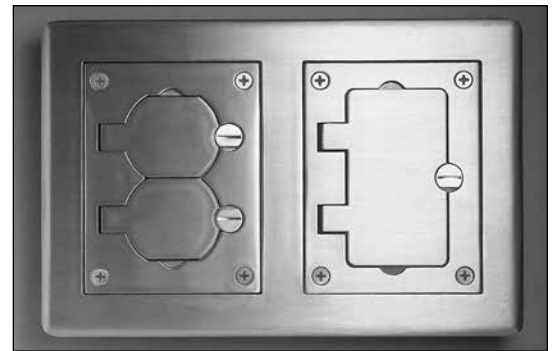
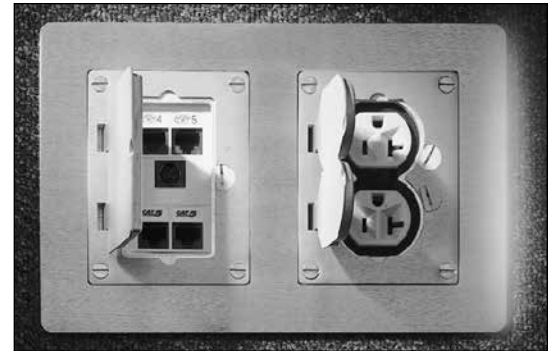

Flush brass and aluminum two-gang fittings for Walkerduct Pro Series.

### FEATURES & BENEFITS

- **Brushed aluminum activations.** Provides additional finish options for better aesthetics.
- **Flush activation assemblies for carpet and tile.** Aesthetically pleasing fittings with low profile connections for power and communications.
- **Communication connectivity options.** Accepts industry standard and proprietary devices from a wide range of manufacturers to provide a seamless and aesthetically pleasing interface for voice, data, audio, and video applications at the point-of-use.
- **Flush carpet plates provide ease of connections.** Saves time and money. The preset and cover replace the need for a handy box to make conduit connections or splicing connections.
- **525 Series Service Fittings and Multiplex Series Service Fittings mount on preset.** For those applications where a pedestal fitting is desired, traditional activations can be attached to the preset.
- **Flush flanges and covers match Walker® Floor Boxes.** When products are installed in the same area, they offer a uniform appearance.
- **Wide range of activations.** Whatever the requirement, there are several options to choose from without compromising aesthetics, functionality, or durability.

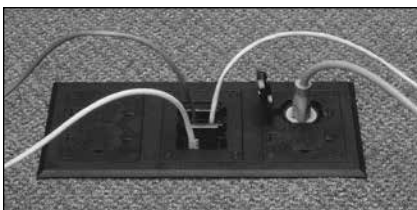

Flush nonmetallic three-gang service fitting for Walkerduct Pro Series.

#### – IMPORTANT –

A minimum 1 1/2" preset or afterset is required on Pro Series underfloor duct to support standard duplex receptacles and communication devices when using flush activations. The 1" preset or afterset should be specified for pedestal style fittings or when cabling will be pulled through the activation point.

## Walkerduct Pro Series Flush Brass Flanges Ordering Information

**Catalog No./Item**      **Description/Specifications**

**817B**

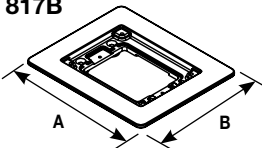

**One-Gang Brass Carpet and Tile Flange** – Accepts Ortronics MAB6TJ TracJack and MAB3S2 Series II bezels, Activate CM-MAB bezel, and Wiremold Open System inserts, all sold separately.

FLANGE	Inches	A [mm]	Inches	B [mm]
817B	6.080	[154.4]	5.060	[128.5]

**827B**

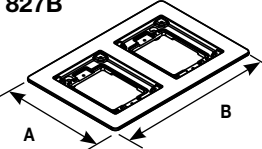

**Two-Gang Brass Carpet and Tile Flange** – Accepts Ortronics MAB6TJ TracJack and MAB3S2 Series II bezels, Activate CM-MAB bezel, and Wiremold Open System inserts, all sold separately.

FLANGE	Inches	A [mm]	Inches	B [mm]
827B	6.080	[154.4]	9.185	[233.3]

**837B**

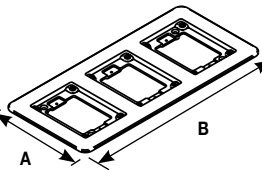

**Three-Gang Brass Combination Carpet and Tile Flange** – Accepts Ortronics MAB6TJ TracJack and MAB3S2 Series II bezels, Activate CM-MAB bezel, and Wiremold Open Systems inserts, all sold separately.

FLANGE	Inches	A [mm]	Inches	B [mm]
837B	6.080	[154.4]	13.310	[338.1]

**828R**

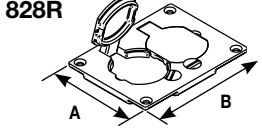

**Brass Duplex Cover Plate** – Flip lids. Can also be used with a 106 type communication bezel.

COVER	Inches	A [mm]	Inches	B [mm]
828R	3.156	[80.2]	4.182	[106.2]

**828GFITC**

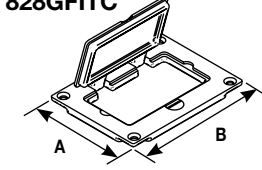

**Brass GFI Cover Plate** – May be used with Activate and Ortronics Connectivity Systems in conjunction with 817, 827 and 837 Series flanges.

COVER	Inches	A [mm]	Inches	B [mm]
828GFITC	3.156	[80.2]	4.182	[106.2]

**828DPGFITC**

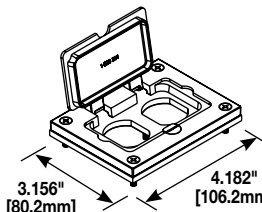

**Brass Rectangular Cover Plate** – Allows for mounting of a duplex style receptacle with a rectangular flip lid cover plate.

COVER	Inches	A [mm]	Inches	B [mm]
828DPGFITC	3.156	[80.2]	4.182	[106.2]

**Catalog No./Item**      **Description/Specifications**

**828SPTC**

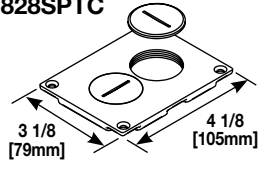

**Brass Duplex Cover Plate** – Screw plugs. Screw plugs are 1 1/2" [38mm] in diameter.

**NOTE: Not available in Brushed Aluminum finish.**

**829STC**

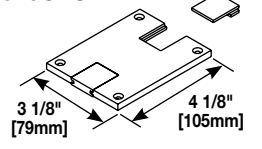

**Brass Communication Cover Plate** – Data slides. Feed through only, not for use with a mounting plate for communication jacks.

**NOTE: Not available in Brushed Aluminum finish.**

**829CK**

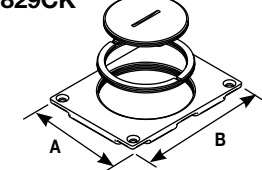

**Brass Communication Cover Plate** – 2 5/8" and 2 1/4" [67mm and 57mm] plugs.

COVER	Inches	A [mm]	Inches	B [mm]
829CK	3.156	[80.2]	4.182	[106.2]

**829CK-1**

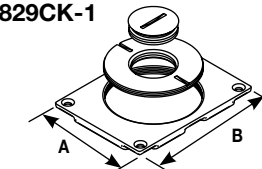

**Brass Communication Cover Plate** – 2 5/8" and 3/4" [67mm and 19.1mm] plugs.

COVER	Inches	A [mm]	Inches	B [mm]
829CK-1	3.156	[80.2]	4.182	[106.2]

**829CK-3/4**

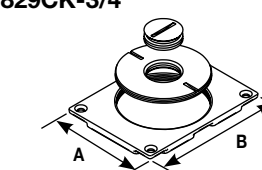

**Brass Communication Cover Plate** – 2 5/8" and 3/4" [67mm and 19.1mm] plugs.

COVER	Inches	A [mm]	Inches	B [mm]
829CK-3/4	3.156	[80.2]	4.182	[106.2]

**829CK-1/2**

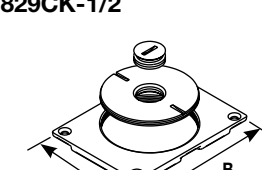

**Brass Communication Cover Plate** – 2 5/8" and 1/2" [67mm and 12.7mm] plugs.

COVER	Inches	A [mm]	Inches	B [mm]
829CK-1/2	3.156	[80.2]	4.182	[106.2]

**NOTE: Brass covers and flanges ARE NOT interchangeable with aluminum or nonmetallic covers and flanges. Nonmetallic covers ARE interchangeable with aluminum flanges.**

## Walkerduct Pro Series Flush Brushed Aluminum Flanges Ordering Information

**Catalog No./Item**      **Description/Specifications**

**818TCAL**      **One-Gang Brushed Aluminum Combination Carpet and Tile Flange** – Accepts Ortronics MAB6TJ TracJack and MAB3S2 Series II bezels, Activate CM-MAB bezel, and Wiremold Open System inserts, all sold separately.

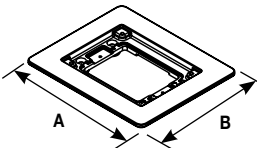

FLANGE	Inches	A [mm]	Inches	B [mm]
818TCAL	5.940	[150.9]	4.920	[125.0]

**NOTE:** Brushed aluminum flanges come with beveled edges.

**828TCAL**      **Two-Gang Brushed Aluminum Combination Carpet and Tile Flange** – Accepts Ortronics MAB6TJ TracJack and MAB3S2 Series II bezels, Activate CM-MAB bezel, and Wiremold Open System inserts, all sold separately.

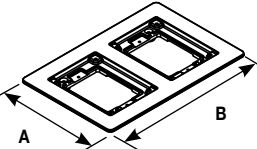

FLANGE	Inches	A [mm]	Inches	B [mm]
828TCAL	5.940	[150.9]	9.045	[239.7]

**NOTE:** Brushed aluminum flanges come with beveled edges.

**838TCAL**      **Three-Gang Brushed Aluminum Combination Carpet and Tile Flange** – Accepts Ortronics MAB6TJ TracJack and MAB3S2 Series II bezels, Activate CM-MAB bezel, and Wiremold Open Systems inserts, all sold separately.

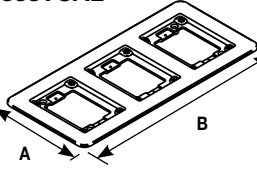

FLANGE	Inches	A [mm]	Inches	B [mm]
838TCAL	5.940	[150.9]	13.170	[334.5]

**NOTE:** Brushed aluminum flanges come with beveled edges.

**828R-TCAL**      **Brushed Aluminum Duplex Cover Plate** – Flip lids. Can also be used with a 106 type communication bezel.

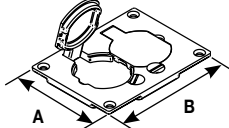

COVER	Inches	A [mm]	Inches	B [mm]
828R-TCAL	3.290	[83.6]	4.310	[109.5]

**828GFITCAL**      **Brass or Brushed Aluminum GFI Cover Plate** – May be used with Activate and Ortronics Connectivity Systems in conjunction with 817, 827 and 837 Series flanges.

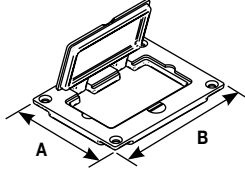

COVER	Inches	A [mm]	Inches	B [mm]
828GFITCAL	3.290	[83.6]	4.310	[109.5]

**Catalog No./Item**      **Description/Specifications**

**828DPGFITCAL**      **Brushed Aluminum Rectangular Cover Plate** – Allows for mounting of a duplex style receptacle with a rectangular flip lid cover plate.

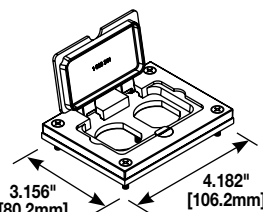

**830CKTCAL**      **Brushed Aluminum Communication Cover Plate** – 2 5/8" and 2 1/4" [67mm and 57mm] plugs.

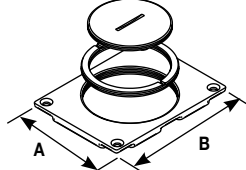

COVER	Inches	A [mm]	Inches	B [mm]
830CKTCAL	3.290	[83.6]	4.310	[109.5]

**830CKTCAL-1**      **Brushed Aluminum Communication Cover Plate** – 2 5/8" and 1" [67mm and 25mm] plugs.

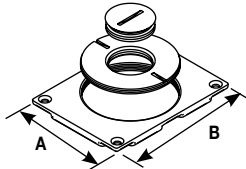

COVER	Inches	A [mm]	Inches	B [mm]
830CKTCAL-1	3.290	[83.6]	4.310	[109.5]

**830CKTCAL-3/4**      **Brushed Aluminum Communication Cover Plate** – 2 5/8" and 3/4" [67mm and 19.1mm] plugs.

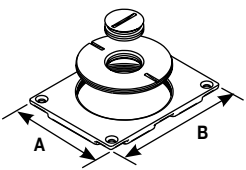

COVER	Inches	A [mm]	Inches	B [mm]
830CKTCAL-3/4	3.290	[83.6]	4.310	[109.5]

**830CKTCAL-1/2**      **Brushed Aluminum Communication Cover Plate** – 2 5/8" and 1/2" [67mm and 12.7mm] plugs.

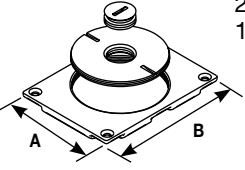

COVER	Inches	A [mm]	Inches	B [mm]
830CKTCAL-1/2	3.290	[83.6]	4.310	[109.5]

**NOTE:** Brass covers and flanges ARE NOT interchangeable with aluminum or nonmetallic covers and flanges. Nonmetallic covers ARE interchangeable with aluminum flanges.

## Walkerduct Pro Series Flush Non-Metallic Covers Ordering Information

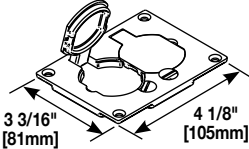
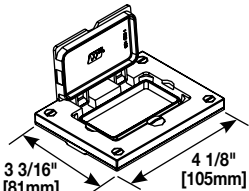
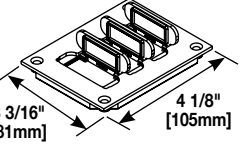
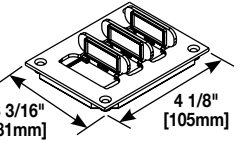
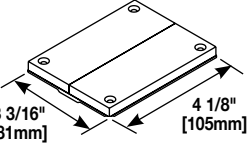
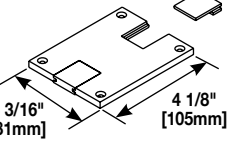
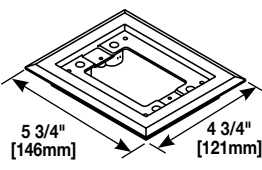
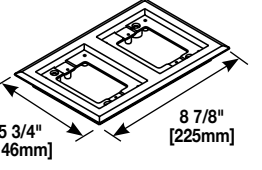
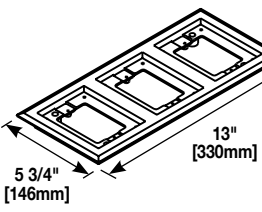
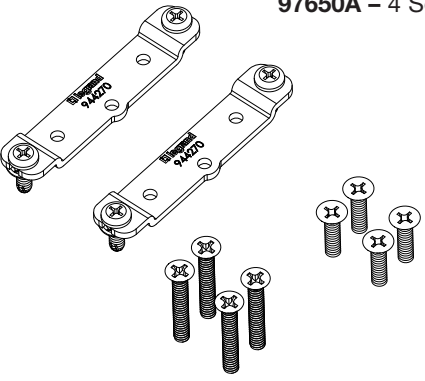
Catalog No./Item	Description/Specifications
<b>828PR-BLK</b> <b>828PR-BRN</b> 	<b>Nonmetallic Duplex Cover Plate</b> – Flip lids. Available in black or brown. Can also be used with a 106 type communication bezel.
<b>828PRGFI-BLK</b> <b>828PRGFI-BRN</b> 	<b>Nonmetallic GFI Cover Plate</b> – Available in black or brown. May be used with Activate and Ortronics Connectivity systems in conjunction with 817, 827 and 837PCC Series flanges.
<b>829PFL-BLK*</b> <b>829PFL-BRN*</b> 	<b>Nonmetallic Communication Cover Plate</b> – Individual flip lids. Available in black or brown. Gasket included. Accepts Activate CM-MAB bezel, and Wiremold Open System inserts, all sold separately.
<b>829PFLRT-BLK*</b> <b>829PFLRT-BRN*</b> 	<b>Nonmetallic Communication Cover Plate</b> – Individual flip lids. Available in black or brown. Gasket included. Accepts Ortronics MAB6TJ TracJack and MAB3S2 Series II bezels included.
<b>829PCK-BLK</b> <b>829PCK-BRN</b> 	<b>Nonmetallic Communication Cover Plate</b> – Breakouts. Available in black or brown. Feed through only, not for use with a mounting plate for communication jacks.
<b>829PSTC-BLK</b> <b>829PSTC-BRN</b> 	<b>Nonmetallic Communication Cover Plate</b> – Data slides. Available in black or brown. Feed through only, not for use with a mounting plate for communication jacks.
<b>817PCC-BLK</b> <b>817PCC-BRN</b> 	<b>One-Gang Nonmetallic Carpet and Tile Flange</b> – Available in black or brown. Accepts Ortronics MAB6TJ TracJack and MAB3S2 Series II bezels, Activate CM-MAB bezel, and Wiremold Open System inserts, all sold separately.
<b>827PCC-BLK</b> <b>827PCC-BRN</b> 	<b>Two-Gang Nonmetallic Carpet and Tile Flange</b> – Available in black or brown. Accepts Ortronics MAB6TJ TracJack and MAB3S2 Series II bezels, Activate CM-MAB bezel, and Wiremold open inserts, all sold separately.
<b>837PCC-BLK</b> <b>837PCC-BRN</b> 	<b>Three-Gang Nonmetallic Carpet and Tile Flange</b> – Available in black or brown. Accepts Ortronics MAB6TJ TracJack and MAB3S2 Series II bezels, Activate CM-MAB bezel, and Wiremold Open System inserts, all sold separately.
<b>PALSTRAP</b> <b>Link Strap Hardware Bag</b> <b>97650A</b> – 4 Sets per envelope	
	

\* Replacement flip lids can be ordered under Cat. No. PFL-BLK and PFL-BRN. Each Cat. No. comes with three flip lids. The above cover plates are listed for tile and carpet applications.

**NOTE:** Brass covers and flanges **ARE NOT** interchangeable with aluminum or nonmetallic covers and flanges. Nonmetallic covers **ARE** interchangeable with aluminum flanges

## Walkerduct Pro Series Flush Carpet Plates

For those applications where a basic connection is needed out of the preset, steel carpet plates are available. Made of 14 ga. galvanized steel, these plates provide a sturdy activation for conduit or receptacle connections. The plate dimensions are 3 7/8" wide x 4 5/8" long [98mm x 117mm]. Hardware for attaching to preset is included with plates. Screws provide 1 11/16" [43mm] upward adjustment.

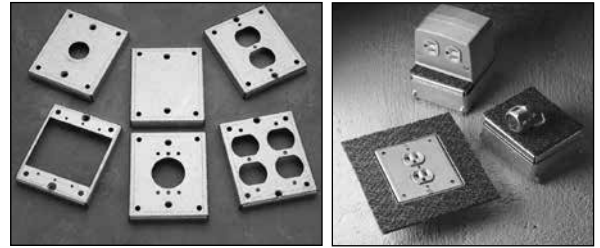

Steel carpet plates provide a sturdy activation for conduit or receptacle connections.

**– IMPORTANT! –**

Flush carpet plates are to be used only within a protected, enclosed environment such as under a retail counter on carpeted floors.

### Walkerduct Pro Series Flush Carpet Plates Ordering Information

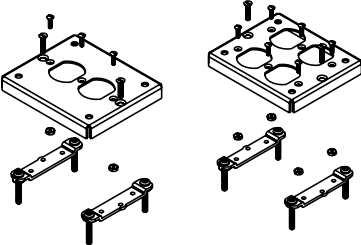
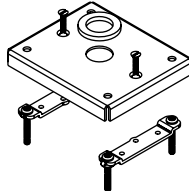
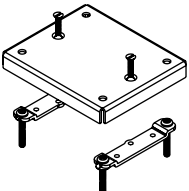
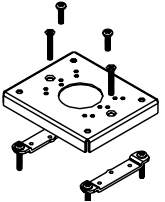
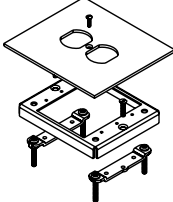
Catalog No./Item	Description/Specifications
<p>428DR 428DR2</p> 	<p><b>Flush Carpet Plate</b> – Single or double duplex opening. Flush plate is 3 7/8" x 4 5/8" [98mm x 117mm].</p> <div style="border: 1px solid black; padding: 10px; margin-top: 10px;"> <p style="text-align: center;"><b>– IMPORTANT –</b></p> <p>A minimum 1 1/2" preset or afterset is required on Pro Series underfloor duct to support standard duplex receptacles and communication devices when using flush activations. The 1" preset or afterset should be specified for pedestal style fittings or when cabling will be pulled through the activation point.</p> </div>
<p>428B075</p> 	<p><b>Flush Carpet Plate</b> – Opening fits 3/4" trade size conduit or liquidtite. Includes spacer for liquidtite connection. Flush plate is 3 7/8" x 4 5/8" [98mm x 117mm].</p>
<p>428BL</p> 	<p><b>Flush Carpet Plate</b> – Blank plate for abandoning preset or can be field punched for custom sized opening. Flush plate is 3 7/8" x 4 5/8" [98mm x 117mm].</p>
<p>428B525</p> 	<p><b>Flush Carpet Plate</b> – To attach 525 Series Service Fitting. Center hole diameter is 1 5/8" [41mm]. Flush plate is 3 7/8" x 4 5/8" [98mm x 117mm].</p>
<p>433DR 433DR2</p> 	<p><b>Flush Carpet Plate</b> – Single or double duplex opening with finishing plate. Oversized plate covers flush plate and carpet edges. Finishing plate is 4 3/4" x 5 3/8" [121mm x 137mm]. Flush plate is 3 7/8" x 4 5/8" [98mm x 117mm].</p> <div style="border: 1px solid black; padding: 10px; margin-top: 10px;"> <p style="text-align: center;"><b>– IMPORTANT –</b></p> <p>A minimum 1 1/2" preset or afterset is required on Pro Series underfloor duct to support standard duplex receptacles and communication devices when using flush activations. The 1" preset or afterset should be specified for pedestal style fittings or when cabling will be pulled through the activation point.</p> </div>

## Walkerduct Pro Series Trim Plates

Available in brass or brushed aluminum, blanking plates can be used to cover an abandoned preset opening. They can also be used under a 525 Series Service Fitting or a conduit connector. Hardware to attach plate to preset is included.

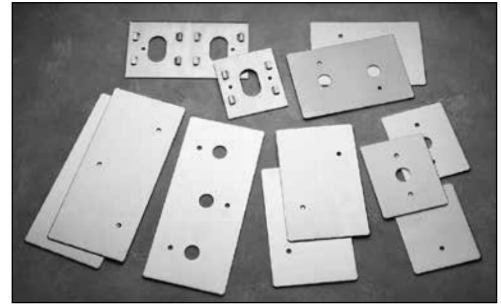

### Walkerduct Pro Series Trim Plates Ordering Information

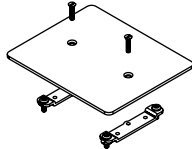
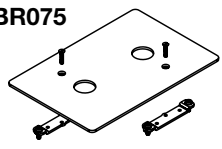
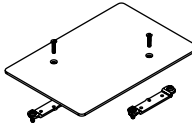
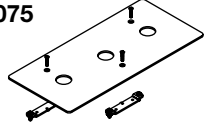
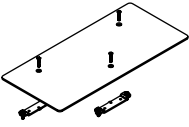
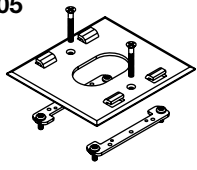
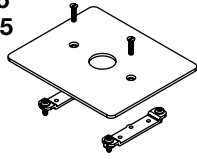
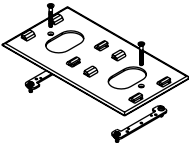
Catalog No./Item	Description/Specification	Catalog No./Item	Description/Specification
430AL 430BR	 <p><b>Single Blanking Plate</b> – In brass or aluminum. Dimensions are 5 1/16" x 6 1/16" [129mm x 154mm].</p>	431AL075 431BR075	 <p><b>Double Conduit Trim Plate</b> – In brass or aluminum. Two openings for 3/4" trade size conduit or liquidtite. Dimensions are 9 3/16" x 6 1/16" [233mm x 154mm].</p>
431AL 431BR	 <p><b>Double Blanking Plate</b> – In brass or aluminum. Dimensions are 9 3/16" x 6 1/16" [233mm x 154mm].</p>	432AL075 432BR075	 <p><b>Triple Conduit Trim Plate</b> – In brass or aluminum. Three openings for 3/4" trade size conduit or liquidtite. Dimensions are 9 3/16" x 6 1/16" [233mm x 154mm].</p>
432AL 432BR	 <p><b>Triple Blanking Plate</b> – In brass or aluminum. Dimensions are 13 5/16" x 6 1/16" [338mm x 154mm].</p>	430S505	 <p><b>Single 525 Trim Plate</b> – To attach 525 Series Service Fitting on top of preset. Aluminum finish only. Dimensions are 5 1/16" x 6 1/16" [129mm x 154mm]. Fits all 525 Series Service Fittings.</p>
430AL075 430BR075	 <p><b>Single Conduit Trim Plate</b> – In brass or aluminum. Opening for 3/4" trade size conduit or liquidtite. Dimensions are 5 1/16" x 6 1/16" [129mm x 154mm].</p>	431D505	 <p><b>Double 525 Trim Plate</b> – To attach two 525 Series Service Fittings on top of preset. Aluminum finish only. Dimensions are 9 3/16" x 6 1/16" [233mm x 154mm]. Fits all 525 Series Service Fittings.</p>

### Walkerduct Pro Series Activations Ordering Information

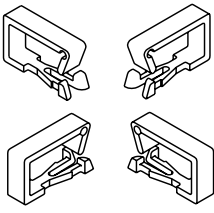
Catalog No./Item	Description/Specifications
427	 <p><b>Fiber Loop Kit</b> – Nonmetallic clips snap into tabs in preset base. Holds up to one meter of fiber optic or UTP cable. Maintains 1 1/4" [32mm] bend radius.</p>

**NOTE:** See ED1225 for ordering information on 525 Series Service Fittings.

Source I® and Source II® Service Fittings ARE NOT compatible with Walkerduct Pro Series Presets. Source I can be used as an afterset only. 817B, 817PCC and 817TCAL Series cannot be installed on Walkerduct Source II® Systems.



# NOTES



**Legrand, North America**  
60 Woodlawn Street  
West Hartford, CT 06110  
877-295-3472  
[www.legrand.us](http://www.legrand.us)

**Canada**  
844-977-3783  
[www.legrand.ca](http://www.legrand.ca)

FOLLOW US

