

MOUNTING BRACKET  
(2) INCLUDED

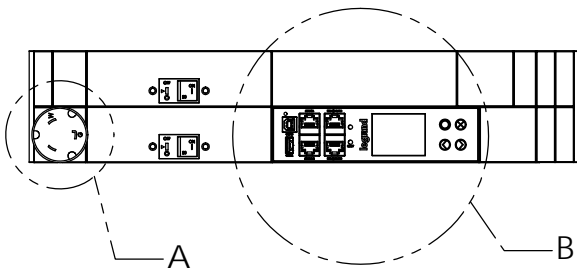

ELECTRICAL PARAMETERS:

- SINGLE PHASE, 24A/120V, 2.9kVA
- INPUT TYPE: NEMA L5-30P, 10' CORD
- OUTPUT TYPE: (16) NEMA 5-20R

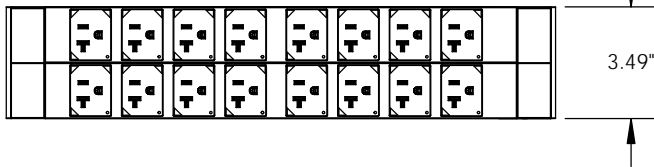
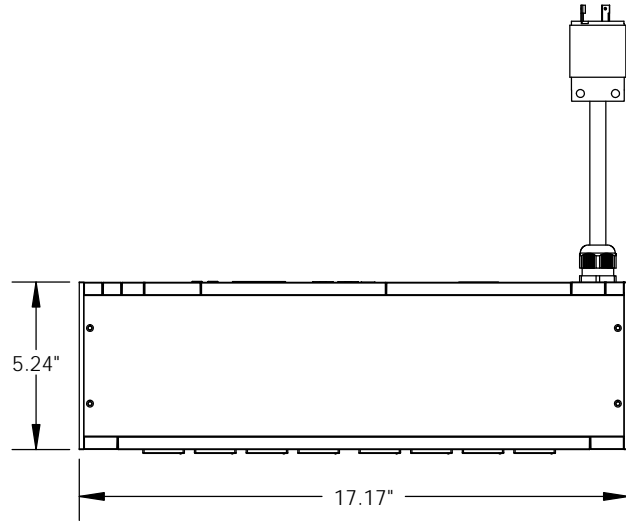
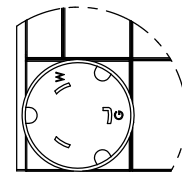
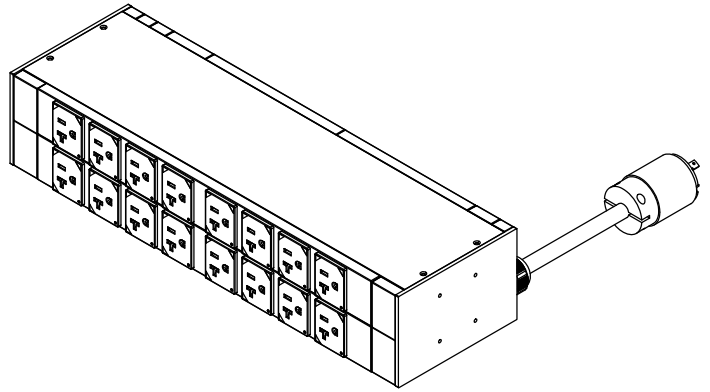

DETAIL A  
NEMA L5-30P

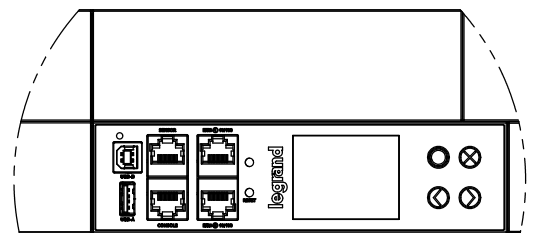
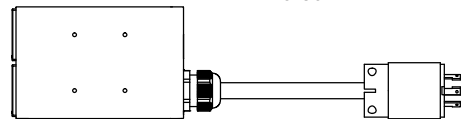

DETAIL B  
SCALE 1 : 3

NOTES:

1. INSTALLATION SHALL COMPLY WITH ALL APPLICABLE NATIONAL, STATE, AND LOCAL CODES.
2. PLEASE REFER TO PRODUCT DOCUMENTATION FOR FURTHER INFORMATION.
3. MOUNTING HARDWARE NOT INCLUDED.

\*\*\* NOTICE \*\*\*  
THIS DOCUMENT CONTAINS CONFIDENTIAL AND/OR PROPRIETARY INFORMATION INTENDED FOR USE ONLY BY THE INDIVIDUAL(S) PROVIDED. NEITHER THIS DOCUMENT, NOR ANY INFORMATION CONTAINED HEREIN, MAY BE COPIED, DISTRIBUTED, DISCLOSED TO ANY THIRD PARTY OR USED IN ANY MANNER OTHER THAN FOR WHICH IT HAS BEEN PROVIDED, WITHOUT THE PRIOR WRITTEN CONSENT OF LEGRAND. MANUFACTURING RELEASE. PRODUCT SPECIFICATIONS AND STANDARDS ARE SUBJECT TO CHANGE WITHOUT NOTICE.



WWW.LEGRAND.US

TITLE

RACK, PDU, NETWORK SWITCHED, 2U,  
24A, 120V, (16) 5-20R, L5-30P CORD

	NAME	DATE	SIZE	CAD FILE	DWG NO	REV
DWN	CAC	1/22/2019	A	LP61320C	LP61320	00
CHK	MM	1/22/2019	SCALE	1:8	SHEET	1 OF 1
APPR	CV	1/25/2019				