

FACEPLATE (FP)

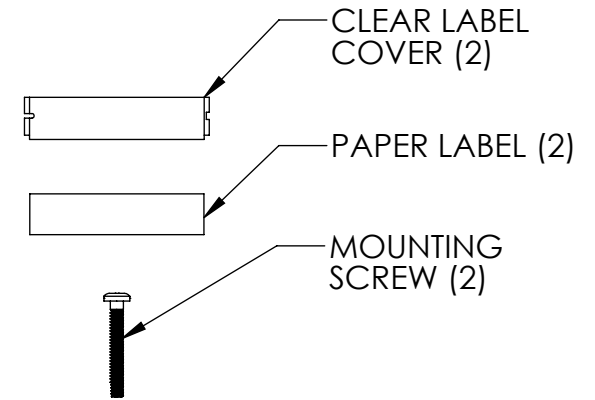
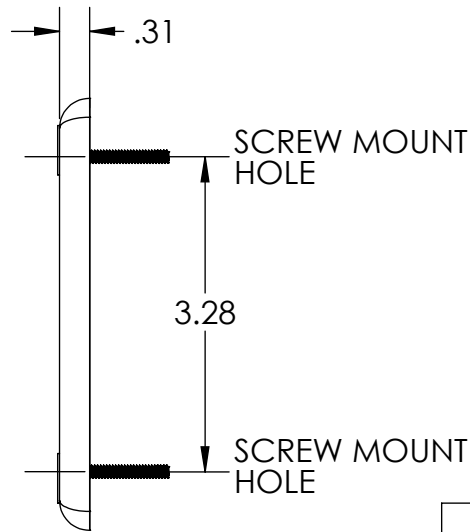
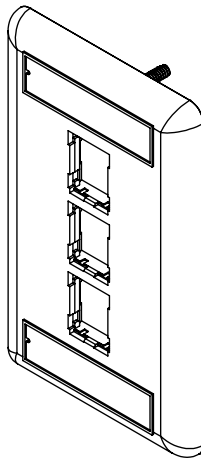

PART NUMBER	(-XX)	COLOR
403HDJ13	NONE	FOG WHITE
403HDJ13-00	-00	BLACK
403HDJ13-13	-13	IVORY
403HDJ13-78	-78	WM DK GRAY
403HDJ13-88	-88	WHITE
403HDJ13-99*	-99*	WM IVORY*

*ASTERISK DENOTES MOQ REQUIRED. CONTACT CUSTOMER SERVICE.

NOTE: ALL DIMENSIONS ARE IN INCHES.

*** NOTICE ***
 THIS DOCUMENT CONTAINS CONFIDENTIAL AND/OR PROPRIETARY INFORMATION INTENDED FOR USE ONLY BY THE INDIVIDUAL(S) PROVIDED. NEITHER THIS DOCUMENT, NOR ANY INFORMATION CONTAINED HEREIN, MAY BE COPIED, DISTRIBUTED, DISCLOSED TO ANY THIRD PARTY OR USED IN ANY MANNER OTHER THAN FOR WHICH IT HAS BEEN PROVIDED, WITHOUT THE PRIOR WRITTEN CONSENT OF LEGRAND, INC.



WWW.LEGRAND.US

TITLE

FP, HDJ, 1 GANG, 3 PORT,
 LABEL, COVER, SCREW KIT

	NAME	DATE	SIZE	CAD FILE	DWG NO	REV
DWN	RWS	8/8/2011	A	403HDJ13XXC	403HDJ13-XX	01
CHK	C.A.COLLELO	12/7/2011	SCALE 1:2		WEIGHT	SHEET 1 OF 1
APPR	W. DIETZ	12/7/2011				