

Catalog Numbers • Les Numéros de Catalogue • Números de Catálogo: FS-505/FS-505C

Country of Origin: Made in China • Pays d'origine: Fabriqué en Chine • País de origen: Hecho en China

SPECIFICATIONS

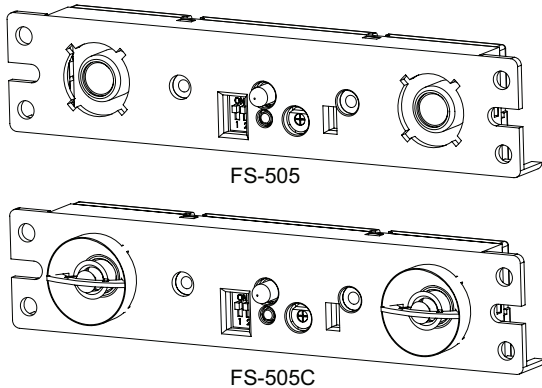

Power

Voltage	24VDC
Current Consumption	43 mA
Power Supply	Wattstopper FS-PP Power Pack
Time Delay Adjustments.....	5, 10, 15 or 30 minutes
Test Mode.....	5 second time delay for 5 minutes
FS-505 coverage @ 8' height at 20° angle from vertical	24' min. linear, 6' min. at 90° on each side
FS-505C coverage @ 10' height parallel to floor	12' min. radius from center
Operating Temperature	32° to 131°F (0° to 55°C)
Dimensions (see template)	
Body	5.19" x 1.27" x 0.73" (131.8mm x 32.6mm x 18.5mm)
Mounting base.....	6.11" x 1.27" (155.2mm x 32.6mm)
Mounting hole centers.....	5.72" x 0.79" (145.3mm x 20.1mm)

DESCRIPTION AND OPERATION

The FS-505 and FS-505C occupancy sensors turn lighting on and off based on occupancy. The sensors use ultrasonic sensing technology. Once the space is vacant and the time delay elapses (adjustable from 5 to 30 minutes), lights will turn off.

The FS-505 and FS-505C operate at 24VDC. They are designed for installation in a light fixture within 2 feet of an associated power supply. The power supply for the sensors is a FS-PP power pack mounted inside a light fixture. Each Wattstopper FS-PP power pack can supply power for one FS-505 or FS-505C sensor.

The sensors are equipped with a 2' long cable fitted with a shielded male RJ45 plug. The FS-PP has a corresponding female RJ45 receptacle. This cable carries power to the sensor and the 24VDC maintained output to the power pack to signal that lights should be on. Optional cables and connectors are available for alternate configurations.

Important, there is an initial warm-up period:

It may take up to a minute before the lights turn on due to a sensor warm-up period required during initial power-up. This occurs during installation or after a lengthy power failure only.

FS-505C Mounted parallel to floor in ceiling fixture

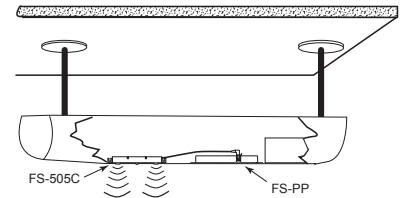

FS-505 Mounted 20' from vertical in wall fixture

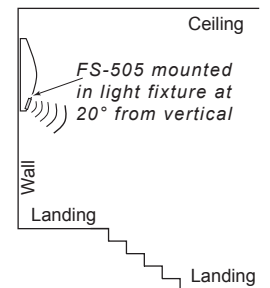

APPLICATIONS

The FS-505C includes directional cones over the transducers.

The FS-505C is designed for use in hanging light fixtures where the cones face downward over the coverage area. This gives the FS-505C a large rectangular shaped coverage pattern (see the **Coverage Pattern** section).

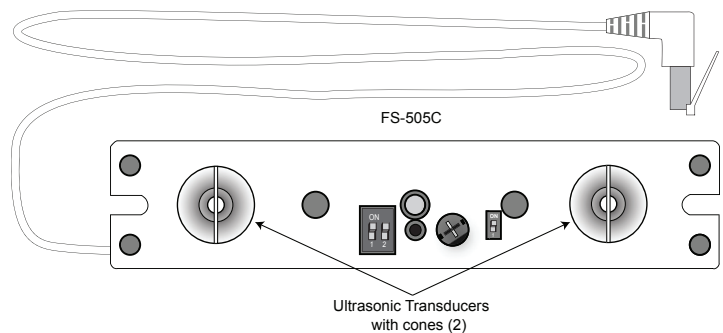

The FS-505 (no cones) is designed for use in wall-mounted lighting fixtures where the transducers face away from the wall at an angle of approximately 20° from vertical. It is particularly well suited for use in stairwell applications, as well as in other wall mount applications.

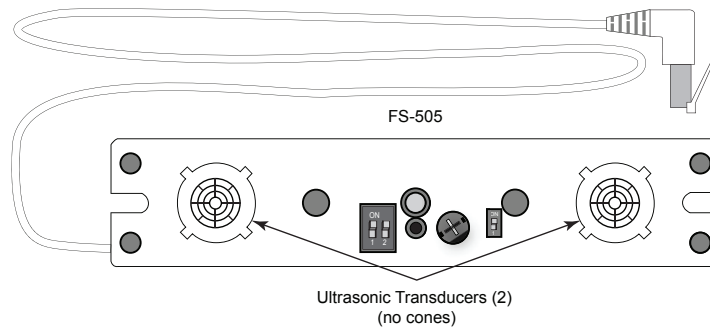

INSTALLATION

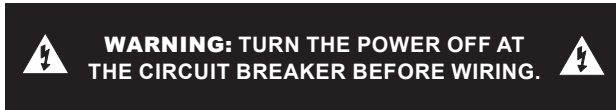

1. Install the FS-PP as directed in the installation instructions provided with the power pack. Review wiring diagrams below and on page 5, to determine appropriate load wiring to the FS-PP and Occupancy Mode Switch setting for the FS-505.
2. Determine an appropriate mounting location inside the light fixture.
3. See template for dimensions to determine cut-out and mounting hole locations in the fixture.
4. Install the sensor to the inside of the fixture using screws.
5. Plug the FS-505 into the FS-PP.
6. Restore power from the circuit breaker.

Key Product Dimensions

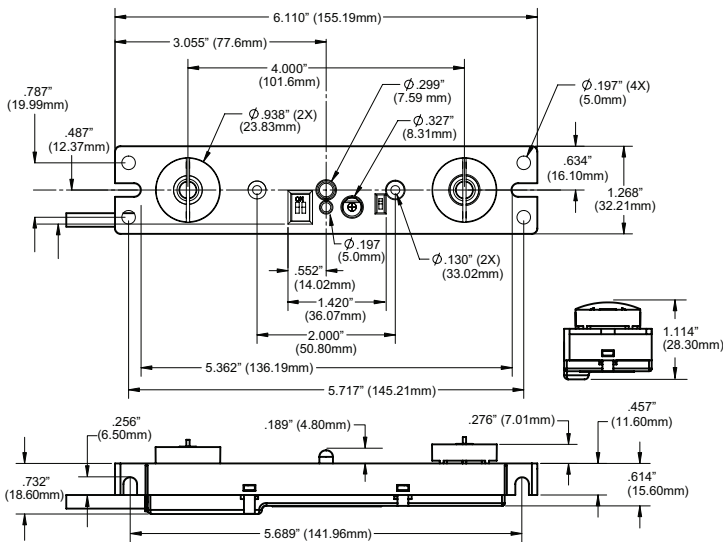

Cut-Out on Fixture

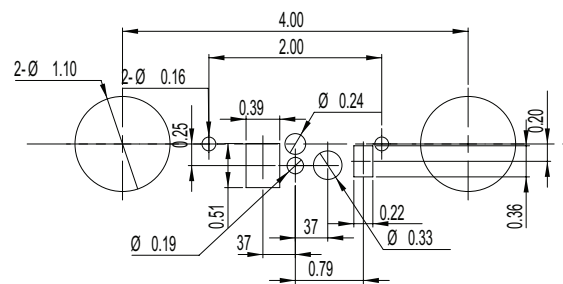

WIRING A SINGLE SENSOR

All power wiring goes through the FS-PP. The only connection to the FS-505 is through the RJ45. The Occupancy Mode Switch should be set to **ON** for these wiring configurations.

FS-PP direct wiring to lighting load

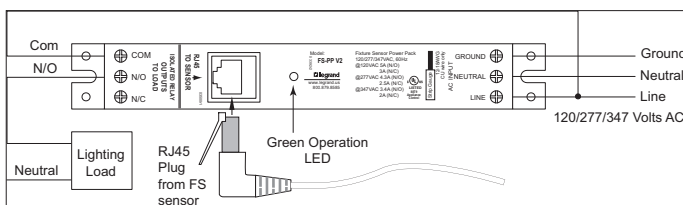

FS-PP wiring to control ballast

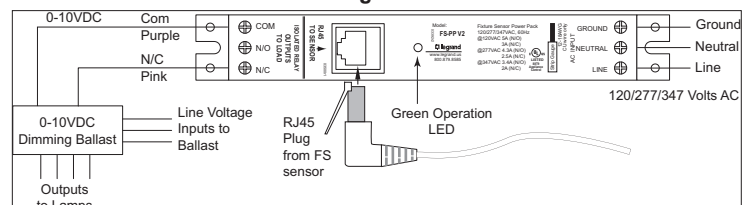

NOTE: Per UL, the 0-10V negative dimming wire color has been changed from gray to pink.

CONTROL CONFIGURATIONS

One Sensor controlling one Power Pack



One Sensor controlling two Power Packs

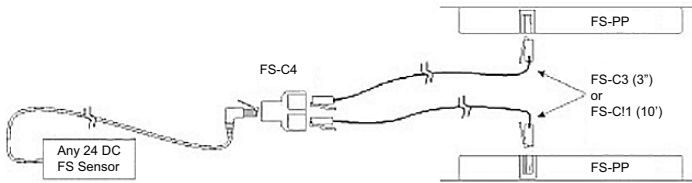

Two Sensors controlling one Power Pack

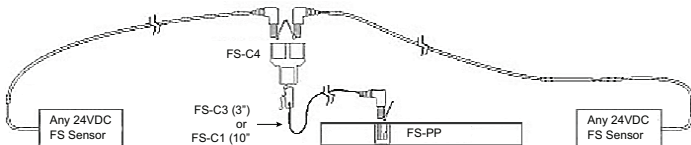

Two Sensors controlling two Power Packs

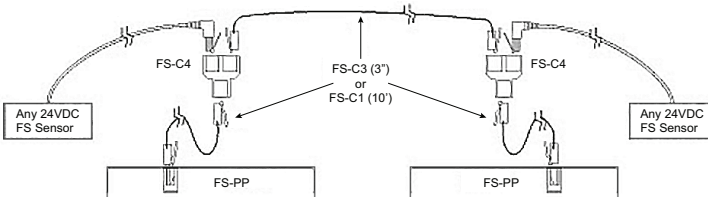

COVERAGE PATTERN

The coverage pattern is determined by sensor model, mounting height and the angle of the sensor, relative to the coverage area floor. The coverage shown represents full-step walking motion in a carpeted area, with no barriers or obstacles at a mounting height of 8 to 10 feet. Mounting above or below this range significantly affects coverage patterns.

Obstacles such as furniture or partitions, wall, ceiling and floor treatments can cause the coverage area to be less or more than the sensing distances shown in the coverage pattern. This must be considered when planning the number of sensors and their placement.

Place sensors at least 4 feet away from air supply ducts.

For complete coverage in open areas, install multiple sensors to provide a 20% overlap with each adjacent sensor's coverage area.

Top view, FS-505C coverage pattern, sensor mounted 8' high, parallel to floor

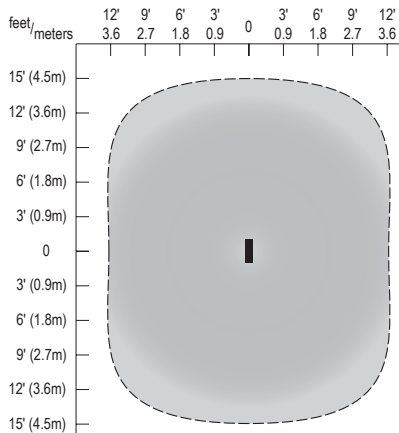

Top view, FS-505C coverage pattern, sensor mounted 20' from vertical

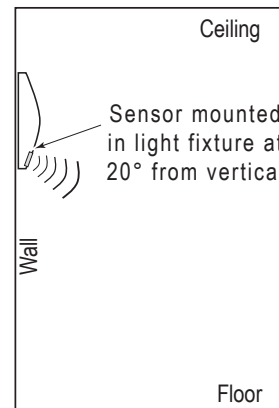
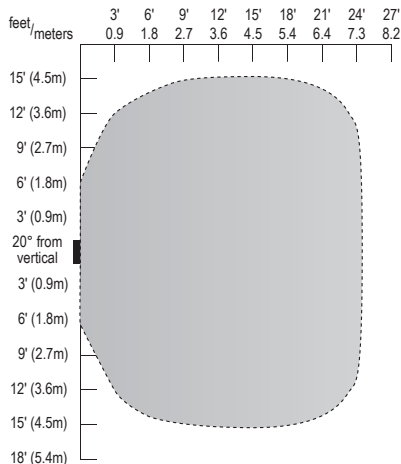

SENSOR ADJUSTMENT

Before making adjustments, install furniture, turn lighting circuits on, and set HVAC systems to the overridden/on position. VAV systems should be set to their highest airflow. Set the Time Delay to the desired setting. See "Time Delay Switches" on the next page.

Factory Default Settings

S2-1 ON, S2-2 OFF, R18 WIPER @ 3.8 V, S3 OFF

To Test Occupancy Sensors

1. Set the Sensitivity adjustment to about mid-range.
2. Activate the Test Mode using the test mode button.
3. Move out of the controlled area - the lights will turn off in about 5 seconds from the last flash of the LED.* If the LED continues to flash, the sensor is detecting some kind of movement. Change the sensitivity adjustment to a lower setting (a few degrees counterclockwise) and repeat this step until the LED does not flash and the lights turn off.
4. * If Reverse-Occupancy is enabled (the lighting load is wired to a normally closed contact and the sensor's Occupancy Mode Switch is ON), operation of the load is also reversed during Test Mode. For example, at this stage of testing, the lights will turn ON in about 5 seconds from the last flash of the LED. See the **Occupancy Mode Switch** section for more information.

5. Walk into the controlled area. If the lights don't turn on, increase the sensitivity (a few degrees clockwise) and try again. Repeat this procedure until the LED does not flash and the lights turn off. If the lights turn off while the room is occupied, it may be necessary to increase the sensitivity.
6. Allow the test period to expire or push the test button again. The sensor will now be in its operating mode.

Adjustment Features

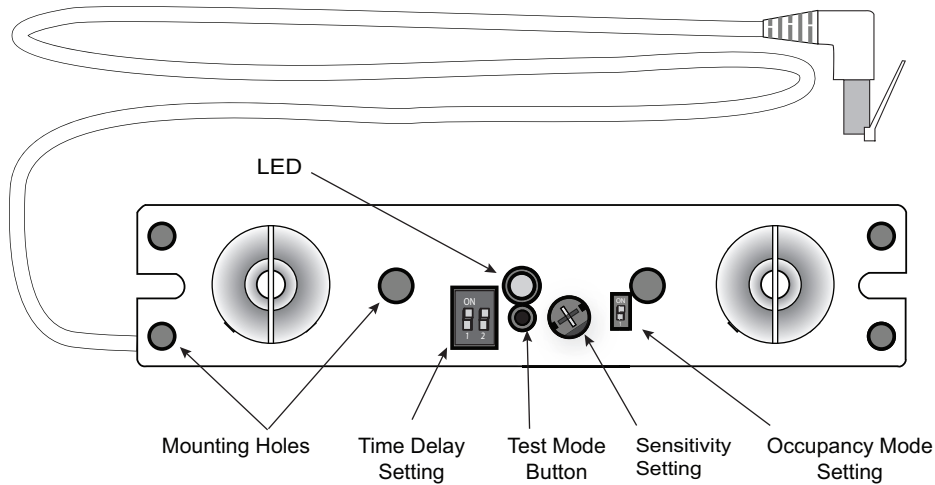

LED

The LED flashes every time the sensor detects motion. The LED is also used to indicate other sensor status such as test mode, lamp burn-in, and override. When the LED flashes at a constant rate of one second on then one second off, the sensor is in the burn-in mode. When the sensor is in Test Mode, the LED flashes to indicate occupancy detections. When the sensor is in Override Mode, the LED glows steady.

TIME DELAY SWITCHES

The sensor will hold the lights ON as long as occupancy is detected. The time delay countdown starts when no motion is detected. After no motion is detected for the length of the time delay, the sensor will turn the lights OFF.

Time Delay	Minutes
12	Minutes
-	5
- •	10
• -	15
• •	30

• on, - off

TEST MODE BUTTON

This button is used to select the Operating Mode for the FS-505.

- A momentary press invokes the Test Mode.
- Press and hold for 5 seconds to invoke the lamp Burn-In mode.
- Press and hold for 10 seconds to Override the sensor output.

The LED lights indicate how long the button is to be held. Initially the LED is cleared when the button is pressed. After 5 seconds it will turn on, and after 10 seconds clear again.

Test Mode

The purpose of the test mode is to be able to quickly determine the coverage area of the sensor without waiting for a lengthy time delay. Test Mode is a temporary state that provides a 5 minute test period. During the test period, the Time Delay is only 5 seconds. After 5 minutes, the sensor returns to the time delay set on the Time Delay switches. To exit from the Test Mode, push the button again or wait for it to time out.

Override

To override sensor functions so that the load stays on, push and hold the button for 10 seconds. Depending on the setting of the Occupancy Mode switch, the output could be overridden ON or OFF. The LED is ON in a steady state when the sensor is in the Override Mode. When in override, the lights can be manually controlled with a light switch, if one is installed. To turn off the Override Mode, momentarily push the button again.

Burn-in

Some lamp and ballast manufacturers recommend running lamps at full output for their first 72 hours of operation. The burn-in function initiates a 72-hour burn-in period. To start the burn-in process, push and hold the button for 5 seconds. The lamps will stay on for 72 hours continuously, regardless of occupancy status. After 72 hours, the sensor returns to normal function. To indicate the sensor is in burn-in mode, the LED flashes rapidly and continuously for the full 72 hours. To turn off the burn-in mode, momentarily push the button again.

OCCUPANCY MODE SWITCH

When the sensor is used with a power pack incorporating a normally closed relay, the Occupancy Mode Switch can be set for Fail-ON functionality, or reverse-occupancy operation. To use the normally closed relay on the FS-PP, wire the lighting load to the NC and COM terminals as shown in Figure 11.

Fail-ON Functionality

To enable Fail-ON functionality, set the Occupancy Mode Switch to OFF and wire the load as shown in Figure 11. In this configuration the sensor works normally, meaning that it turns ON the lights when there is occupancy, and turns OFF the lights when the Time Delay expires. Should the sensor be disconnected or fail, the lights turn ON.

Reverse-Occupancy Functionality

If the switch is set to ON in the N/C wiring configuration, the operation will be reversed. The lights turn ON when there is no occupancy, and turn OFF when there is occupancy. However, if the sensor is removed or fails, the lights will turn ON due to the kickback circuitry in the FS-PP.

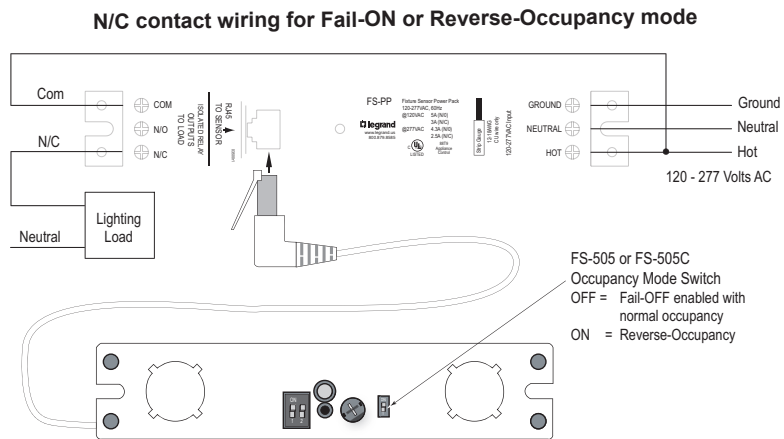

ORDERING INFORMATION

Catalog Number	Description
FS-505	Fixture mount, low voltage ultrasonic occupancy sensor.
FS-505C	Same as FS-505, with directional cones.
FS-PP	Fixture Mount Power Pack, 120-277VAC, 60Hz with NO/NC Relay output.
FS-C1	One 10' cable with a shielded RJ45 male connector at each end.
FS-C2	One 6' cable with flying leads at one end and a shielded RJ45 male connector at the other.
FS-C3	One 3' cable with a shielded 90° RJ45 male connector and a shielded straight male RJ45 connector.
FS-C4	Shielded RJ45 splitter with female to dual female receptacles.
FS-C5	Shielded RJ45 male-to-male couple.
FS-CK-2	RJ45 to 3-wire connection kit.

Sensors and power packs are White.

WARRANTY INFORMATION

Wattstopper warrants its products to be free of defects in materials and workmanship for a period of five (5) years. There are no obligations or liabilities on the part of Wattstopper for consequential damages arising out of, or in connection with, the use or performance of this product or other indirect damages with respect to loss of property, revenue or profit, or cost of removal, installation or reinstallation.

INFORMATIONS RELATIVES À LA GARANTIE

Wattstopper garantit que ses produits sont exempts de défauts de matériaux et de fabrication pour une période de cinq (5) ans. Wattstopper ne peut être tenu responsable de tout dommage consécutif causé par ou lié à l'utilisation ou à la performance de ce produit ou tout autre dommage indirect lié à la perte de propriété, de revenus, ou de profits, ou aux coûts d'enlèvement, d'installation ou de réinstallation.

INFORMACIÓN DE LA GARANTÍA

Wattstopper garantiza que sus productos están libres de defectos en materiales y mano de obra por un período de cinco (5) años. No existen obligaciones ni responsabilidades por parte de Wattstopper por daños consecuentes que se deriven o estén relacionados con el uso o el rendimiento de este producto u otros daños indirectos con respecto a la pérdida de propiedad, renta o ganancias, o al costo de extracción, instalación o reinstalación.